

合格证
QC PASS

Godox

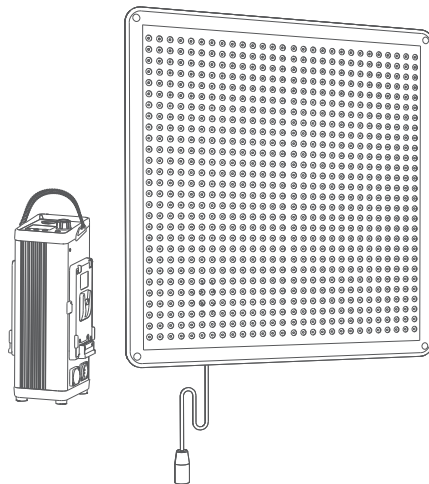

Wechat
Official Account
神牛微信公众号

深圳市神牛摄影器材有限公司

地址: 深圳市宝安区福海街道塘尾社区福川工业区厂房2栋 电话: 0755-29609320(8062)

传真: 0755-25723423 邮箱: godox@godox.com

GODOX Photo Equipment Co.,Ltd.

Add.: Building 2, Yaochuan Industrial Zone, Tangwei Community, Fuhai Street, Bao'an District,

Shenzhen 518103, China Tel: +86-755-29609320(8062) Fax: +86-755-25723423

E-mail: godox@godox.com

godox.com

Made in China | 705-F200BY-00



KNOWLED F200 Bi

柔性LED灯
KNOWLED Flexible LED Light

使用手册
Instruction Manual

Foreword

Thank you for purchasing !

F200Bi is a waterproof bi-color flexible LED light, with power supply of 100V-240V, it can be used worldwide. The characteristics such as controller power supply, stepless brightness adjustment, IP65 protection grade, 4 dimming curves, cold and warm color temperature and various wireless controls enable it suitable for short video shooting, advertising shooting, e-commerce live streaming, commercial photography, film and TV shooting and etc.

Main Features

- Wide CCT range adjustable from 2700K to 8500K.
- Four dimming curves: linear, s-curve, exponential, logarithmic.
- Stepless brightness adjustment from 0% to 100%.
- Various Controlling methods: DMX 512 controller/ APP control via Bluetooth/2.4GHz remote control.
- Protection grade of IP65 keeps the light head and controller from dust and water.
- 11 FX modes: flash, lightning, cloudy, broken bulb, TV, candle, fire, firework, explosion, welding, SOS.

▲Warning

- ▲ Do not look directly at the LED light or illuminate at others' eyes.
- ▲ Do not plug or unplug the power cable or connecting cable when the power is turned on, otherwise personal injuries may occur.
- ▲ Do not cover the heat dissipation vent in working status.
- ▲ Keep out of reach of children.
- ▲ Please make sure to follow the instruction manual and correctly use this professional lighting device.
- ▲ Do not trample on or roll together, please fold along the center for storage.

▲ **The controller is not waterproof, please keep it dry in using.**

Name of Parts

Light Body

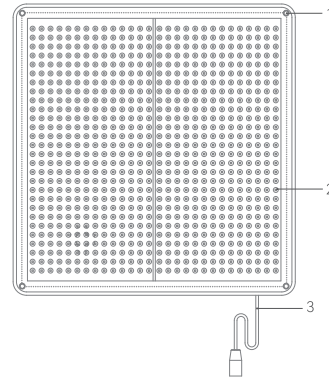

1. Supporting Holes
2. Light Beads
3. Connect Cable

Controller

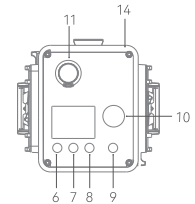
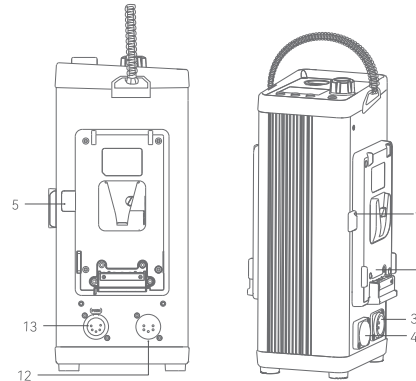

1. Black Battery Remove Button
2. V-mount Battery Holder
3. AC INPUT Port
4. DC 48V INPUT Port
5. Yellow Battery Remove Button
6. /MODE Button
7. PRESET Button
8. MENU Button
9. Power Switch Button
10. SET Select Dial
11. DC OUTPUT Port
12. DMX IN XLR Port
13. DMX OUT XLR Port
14. Type-A Port

Mount the LED Light onto the Light Stand

Install the X Bracket

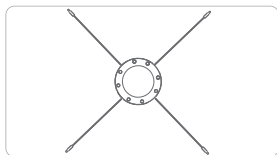

Step 1: Unfold four support bars of the X bracket from the grooves.

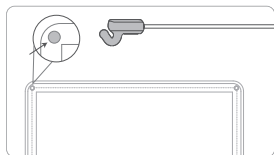

Step 2: Inset four support bars into each of the four supporting holes.

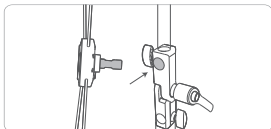

Step 3: Insert the mounting head into the mounting hole of adapter holder, turn the knob to secure.

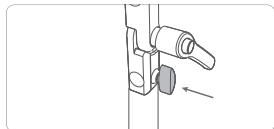

Step 4: Insert the adapter holder into the light stand (optional), turn the knob to lock it in place.

Install the Softbox

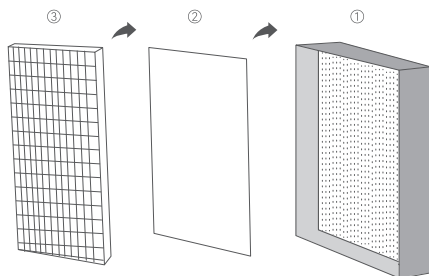

Since softbox, grid and diffuser all have velcros, stick the softbox to the LED light along the sides first, then stick the diffuser and grid in order.

Connect to DMX Controller

The connection operation diagram of DMX controller is as follows:

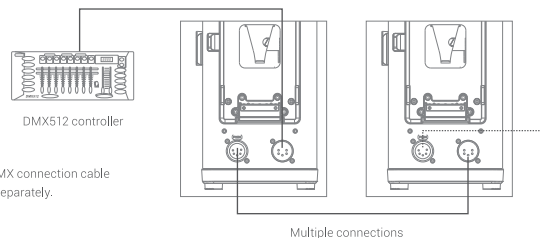

Note: DMX connection cable is sold separately.

What's Inside

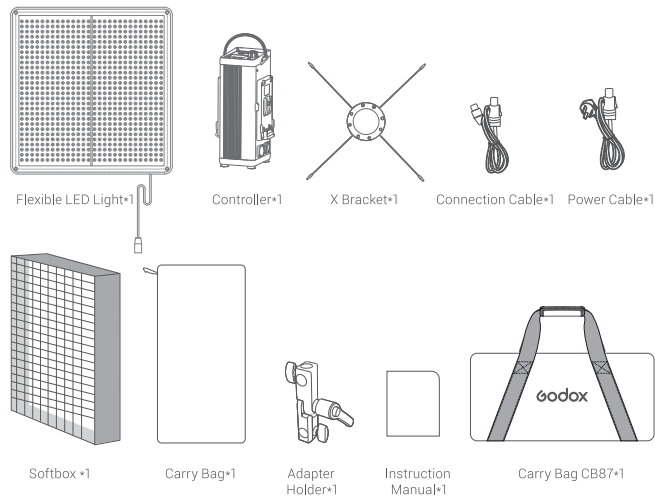

Note: Due to continuous updates and upgrades of the products, there may be differences between the actual products and the pictures. Therefore, the pictures are for reference only, products to prevail in kind.

Separately Sold Accessories



2.4GHz Remote Control RC-A6II



Wireless DMX Transmitter Timolink TX



Wireless DMX Receiver Timolink RX



Controller Fixing Device

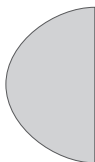

Pancake Lantern FP200

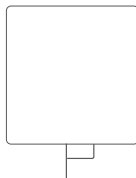

Flag Frame FF200



DC Cable F-DC5A

Power Supply

1.AC Power Supply

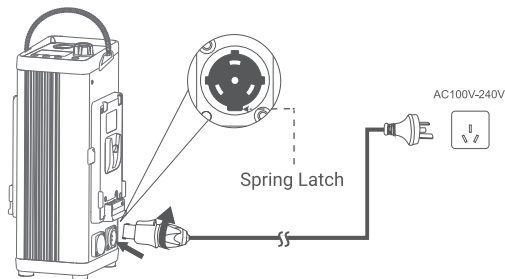

Note : Please press the latch button when disassembling the power cable and connection cable.

2.V-mount battery power supply

Note : The light can be supplied by 14.8V or 26V V-mount battery . Only the side with yellow battery removal button supports one-sided charging . When it is powered by two batteries and one battery is running low on power , the device still can't work normally even if the other one is fully charged . The corresponding battery icon will blink in low battery mode . It is recommended to check whether both batteries have sufficient power when using two batteries

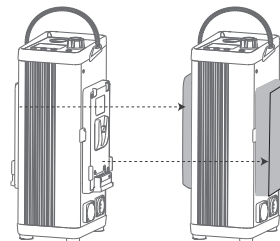

Power Switch

Long press the power switch button on the controller after connecting to power source to turn on the unit or off.

Short pressing the power switch button in the power on state can reduce the brightness to 0%, short press again to restore the previous brightness.

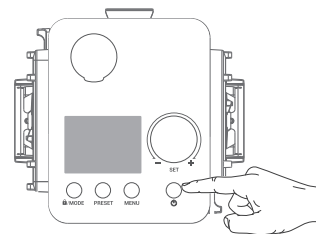

CCT Mode

Short press the >MODE button to switch to CCT mode, short press the select dial to toggle between brightness setting and CCT setting.

1. In the brightness setting interface, turn the select dial to adjust the brightness ratio from 0% to 100%. Rotate the select dial clockwise once can increase the value by 0.1 unit, while rotate counterclockwise once can decrease the value by 0.1 unit. Quick adjustment is also available by rotating quickly.

2. In the color temperature setting interface, turn the select dial to adjust the color temperature from 2700K to 8500K. Rotate the select dial clockwise once can increase the value by 100 units, while rotate counterclockwise once can decrease the value by 100 units.

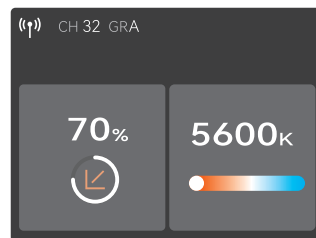

FX Mode

Short press the <  >/MODE button to switch to FX mode, turn the select dial to switch among the following 11 effects: flash, lightning, cloudy, broken bulb, TV, candle, fire, firework, explosion, welding, SOS.

Select the desired effect and short press the select dial to enter the effect setting interface, then short press the <  >/MODE button to return to previous interface.

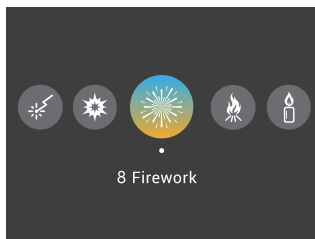

1. Flash Effect

In the flash effect setting interface, turn the select dial to select options among switch, dim, auto, manual, CCT, speed, mode, etc. Short press the select dial to select the desired option then rotate to adjust settings (except for the auto and manual options).

DIM: 0%-100%

CCT: 2700K-8500K

Speed: 1-100

Mode: Camera Flash/Flash Bulb

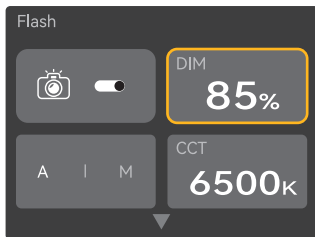

Note: Select manual, then the flash effect can be triggered once by short press the select dial once.

2. Lightning Effect

In the lightning effect setting interface, turn the select dial to select options among switch, dim, auto, manual, CCT, times, frequency, etc. Short press the select dial to select the desired option then rotate to adjust settings (except for the auto and manual options).

DIM: 0%-100%

CCT: 2700K-8500K

Times: Random/1-10

Frequency: Random /2-20

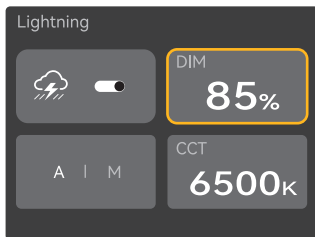

Note: Select manual, then the lightning effect can be triggered once by short press the select dial once.

3. Cloudy Effect

In the cloudy effect setting interface, turn the select dial to select options among switch, dim, ratio, speed, etc. Short press the select dial to select the desired option then rotate to adjust settings.

DIM: 0%-100%

Ratio: 30%-90%

Speed: Random/1-100

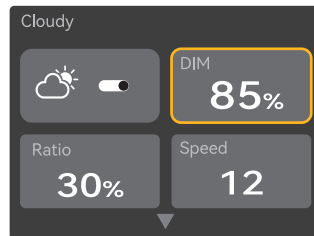

4. Broken Bulb Effect

In the broken bulb effect setting interface, turn the select dial to select options among switch, dim, speed, CCT, etc. Short press the select dial to select the desired option then rotate to adjust settings.

DIM: 0%-100%

Speed: 1-100

CCT: 2700K-8500K

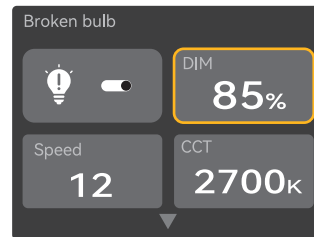

5. TV Effect

In the TV effect setting interface, turn the select dial to select options among switch, dim, speed, etc. Short press the select dial to select the desired option then rotate to adjust settings.

DIM: 0%-100%

Speed: 1-100

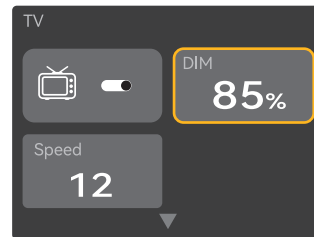

6. Candle Effect

In the candle effect setting interface, turn the select dial to select options among switch, dim, speed, etc. Short press the select dial to select the desired option then rotate to adjust settings.

DIM: 0%-100%

Speed: 1-100

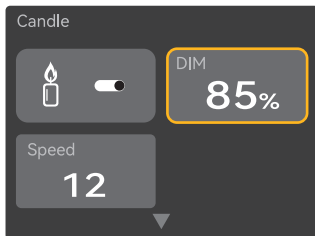

7. Fire Effect

In the fire effect setting interface, turn the select dial to select options among switch, dim, speed, etc. Short press the select dial to select the desired option then rotate to adjust settings.

DIM: 0%-100%

Speed: 1-100

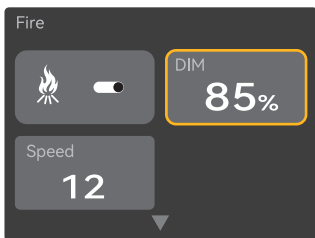

8. Firework Effect

In the firework effect setting interface, turn the select dial to select options among switch, dim, speed, CCT, etc. Short press the select dial to select the desired option then rotate to adjust settings.

DIM: 0%-100%

Speed: 1-100

Embers: 1-100

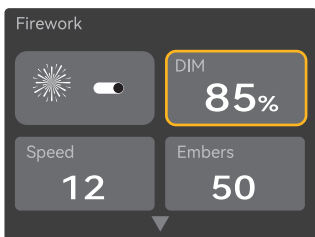

9. Explosion Effect

In the explosion effect setting interface, turn the select dial to select options among switch, dim, auto, manual, CCT, speed, embers, etc. Short press the select dial to select the desired option then rotate to adjust settings (except for the auto and manual options).

DIM: 0%-100%

CCT: 2700K-8500K

Speed: 1-100

Embers: 1-100

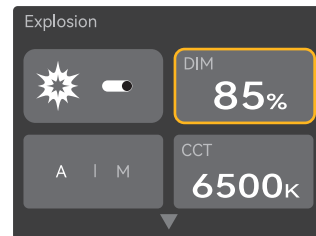

Note: Select manual, then the explosion effect can be triggered once by short press the select dial once.

10. Welding Effect

In the welding effect setting interface, turn the select dial to select options among switch, dim, speed, CCT, etc. Short press the select dial to select the desired option then rotate to adjust settings.

DIM: 0%-100%

Speed: 1-100

CCT: 2700K-8500K

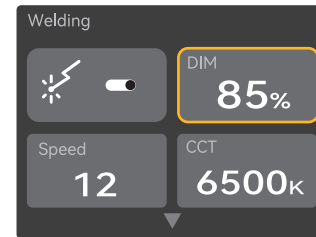

11. SOS Effect

In the SOS effect setting interface, turn the select dial to select options among switch, dim, CCT, etc. Short press the select dial to select the desired option then rotate to adjust settings.

DIM: 0%-100%

CCT: 2700K-8500K

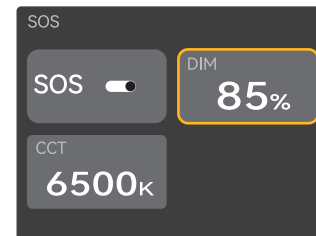

Note: The dimming curve is linear by default in FX mode.

Menu Settings

Short press the MENU button to enter menu settings, turn the select dial to select among the following options: DMX, Bluetooth, wireless, dimming curves, quick boot, display, language, upgrade, factory default, fixture info.

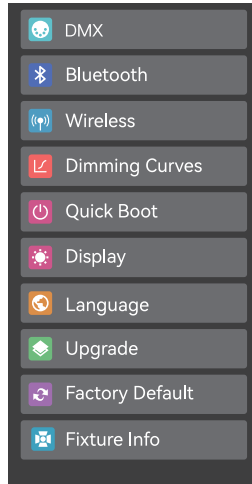

1. DMX

Short press the select dial to enter DMX setting interface. Turn the select dial to select options among address, DMX mode, extend DMX, DMX lost, RDM state. Short press the select dial to select the desired option then rotate to adjust settings. Finally, short press the MENU button to return to the previous menu.

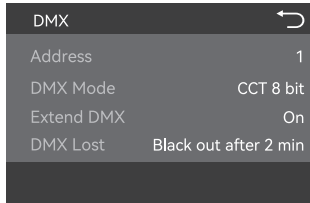

Level 1 Option	Level 2 Option	Description
Address	1-512	Initial address
DMX Mode	CCT 8 bit	CCT 8 bit
	ULTIMATE 8 bit	ULTIMATE 8 bit
	FX 8 bit	FX 8 bit
Extend DMX	On	Turn on extend DMX channels
	Off	Turn off extend DMX channels
DMX Lost	Hold Last Command	After the DMX control signal is lost, continue to use the last received DMX control signal until power down or a valid DMX control signal is received again.
	Black Out	The light is off immediately.
	Black Out After 2 Min	After the DMX control signal is lost, continue to use the last received DMX control signal for 2 minutes then black out. Note: If a valid DMX control signal is received within 2 minutes, then use the new DMX control signal.
RDM Status	On	Turn on RDM, the ADD and DMX mode can be set by controller.
	Off	Turn off RDM

DMX Practical Table

CCT 8Bit Mode						
DMX Channel	Function	Parameters	DMX Value 8 Bit		Practical Parameters Values 8Bit	
			Initial Value	Ending Value	Initial Value	Ending Value
1	CCT	DIM	0	255	0.0%	100.0%
2		CCT	0	255	2700K	8500K

FX 8Bit Mode						
DMX Channel	Function	Parameters	DMX Value 8 Bit		Practical Parameters Values 8Bit	
1		DIM	0	255	0.0%	100.0%
2	FX	FX Type	0	9	Off	
			10	19	Flash	
			20	29	Lightning	
			30	39	Cloudy	
			40	49	Broken Bulb	
			50	59	TV	
			60	69	Candle	
			70	79	Fire	
			80	89	Firework	
			90	99	Explosion	
			100	109	Welding	
			110	119	SOS	
			120	255	Preset	
3	Flash	CCT	0	255	2700K	8500K
4		Speed	0	255	1	100
5		Mode	0	255	0 Camera Flash	1 Flash Bulb
3	Lightning	CCT	0	255	2700K	8500K
4		Times	0	255	0(random)	10
5		Frequency	0	255	0(random)	20
3	Cloudy	DIM Ratio	0	255	30%	90%
4		Speed	0	255	0(random)	100
3	Broken Bulb	CCT	0	255	2700K	8500K
4		Speed	0	255	1	100
3	TV	Speed	0	255	1	100
3	Candle	Speed	0	255	1	100
3	Fire	Speed	0	255	1	100
3		Firework	Speed	0	255	1
4	Explosion	Embers	0	255	1	100
3		CCT	0	255	2700K	8500K
4		Speed	0	255	1	100
5	Welding	Embers	0	255	1	100
3		CCT	0	255	2700K	8500K
4	Speed	0	255	1	100	
3	SOS	CCT	0	255	2700k	8500K

ULTIMATE 8Bit Mode						
DMX Channel	Function	Parameters	DMX Value 8 Bit		Practical Parameters Values 8Bit	
1		DIM	0	255	0.0%	100.0%
2	CCT	Mode	0	9	CCT Mode	
			Selection	10	19	FX Mode
			20	255	Preset	
3		Color Parameter 1				

CCT Parameter in ULTIMATE 8Bit Mode						
DMX Channel	Function	Parameters	DMX Value 8 Bit		Practical Parameters Values 8Bit	
3	CCT	CCT	0	255	2700K	8500K

FX Parameter in ULTIMATE 8Bit Mode						
DMX Channel	Function	Parameters	DMX Value 8 Bit		Practical Parameters Values 8Bit	
3	FX	FX Type	0	9	Off	
			10	19	Flash	
			20	29	Lightning	
			30	39	Cloudy	
			40	49	Broken Bulb	
			50	59	TV	
			60	69	Candle	
			70	79	Fire	
			80	89	Firework	
			90	99	Explosion	
			100	109	Welding	
			110	119	SOS	
		120	255	Preset		
4	Flash	CCT	0	255	2700K	8500K
5		Speed	0	255	1	100
6	Lightning	Mode	0	255	0 Camera Flash	1 Flash Bulb
4		CCT	0	255	2700K	8500K
5		Times	0	255	0(random)	10
6		Frequency	0	255	0(random)	20
4	Cloudy	DIM Ratio	0	255	30%	90%
5		Speed	0	255	0(random)	100
4	Broken Bulb	CCT	0	255	2700K	8500K
5		Speed	0	255	1	100
4	TV	Speed	0	255	1	100
4	Candle	Speed	0	255	1	100
4	Firework	Speed	0	255	1	100
5		Embers	0	255	1	100
4	Explosion	CCT	0	255	2700K	8500K
5		Speed	0	255	1	100
6	Welding	Embers	0	255	1	100
4		CCT	0	255	2700K	8500K
5	Speed	0	255	1	100	
4	SOS	CCT	0	255	2700K	8500K

2. Bluetooth

Short press the select dial to enter Bluetooth setting interface. Turn the select dial to select options between switch and reset. Short press the select dial to select the desired option then rotate to adjust settings. Finally, short press the MENU button to return to the previous menu.

Bluetooth MAC Code is on the left bottom of the display for searching the fixture via Bluetooth.

Scan the QR code to download the "Godox Light" smartphone APP (Available for both Android and Apple system).

Note:

1. The APP can be used directly on the firstly installed device (smartphone or iPad). When change to other mobile device (smartphone or iPad), the light shall be reset before the normal connection of APP.
2. The APP should be upgraded to version 3.0 or above.

3. Wireless

Short press the select dial to enter wireless setting interface. Turn the select dial to select options among switch, GR, CH, ID. Short press the select dial to select the desired option then rotate to adjust settings. Finally, short press the MENU button to return to the previous menu.

Wireless: Turn on/off 2.4G wireless
 GR: 0-9/A-F
 CH: 01-32
 ID: OFF/01-99

4. Dimming Curves

Short press the select dial to enter dimming curves setting interface. Turn the select dial to choose among linear, s-curve, exponential and logarithmic. Finally, short press the select dial/MENU button to return to the previous menu.

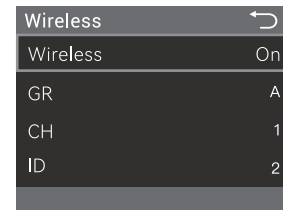
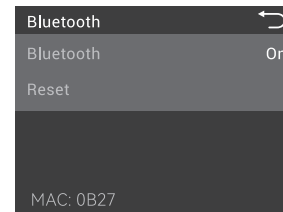

Note: When using the remote control RC-A6iII (sold separately) or remote control RC-R9iII (sold separately), the group, channel and ID of the remote control and F200Bi should be the same.

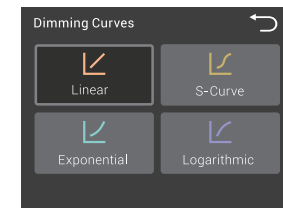

5. Quick Boot

Short press the select dial to enter quick boot setting interface. Turn the select dial to turn on or off the quick boot function. Finally, short press the select dial/MENU button to return to the previous menu.

Note: The controller will turn on automatically after connecting to power source and the quick boot function is turned on.

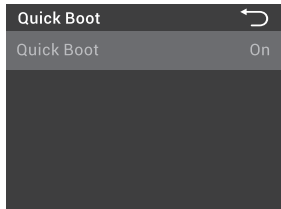

6. Display

Short press the select dial to enter display setting interface. Turn the select dial to adjust display brightness from 20 % to 100%. Finally, short press the MENU button to return to the previous menu.

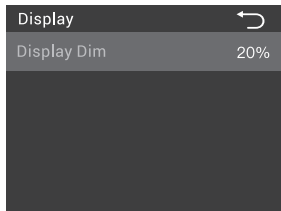

7. Language

Short press the select dial to enter language setting interface. Turn the select dial to select between Chinese and English. Finally, short press the MENU button to return to the previous menu.



8. Upgrade

Short press the select dial to enter upgrade setting interface to check the firmware version and upgrade instruction. Then, short press the MENU button to return to the previous menu.



Firmware Upgrade

1. Download the new firmware to the U disk from official website <https://www.godox.com/firmware-continuous-light>.
2. Turn off the device. Insert the U disk with new firmware into the Type-A USB port.
3. Turn on the device, and it will automatically enter the upgrading interface.
4. It will return to main interface after completion.

Notes:

1. New firmware must be downloaded from the official website, and keep only one BIN file in the root directory of the USB disk.
2. The Type-A USB port can only support output voltage and current of 5V/1A. Do not connect to over-rated USB device.

9. Factory Default

Short press the select dial to enter factory default setting interface. Turn the select dial to select apply or cancel. It will return to language setting interface after reset.

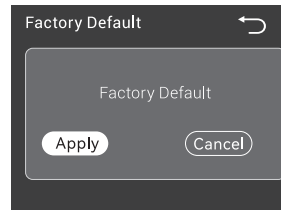

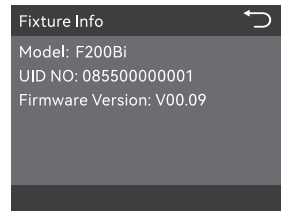

10. Fixture Info

Short press the select dial to enter fixture info setting interface to check model, UID NO. and firmware version. Then, short press the MENU button to return to the previous menu.



Lock Setting

Short press the  /MODE button, the panel is locked when  is displayed on the panel, short press again to unlock.

Note: The locking function only works on the controller panel, other operations are still available.

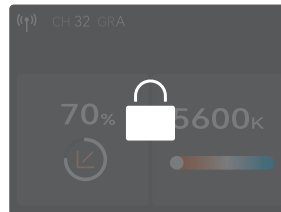

Preset Setting

Short press the PRESET button to enter preset effects interface. Turn the select dial to choose and enter preset effects 1-10, then short press to choose save or cancel. Then, short press the select dial to return to the previous menu and short press the PRESET button to exit.

Note: It will not display any option for certain group that have not been preset any effect.

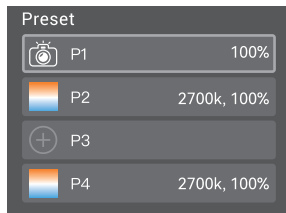

Maintenance

This product, except consumables, is supported with a one-year warranty.

Unauthorized service will void the warranty.

Maintenance of the light must be performed by our authorized maintenance department which can provide original accessories.

Changes made to the specifications or designs may not be reflected in this manual.

Illuminance Data

CCT	Unit	1m	2m	3m
2700K	lux	6680	1910	915
	fc	620	177	85
3200K	lux	7340	2100	1000
	fc	682	195	93
4300K	lux	8070	2300	1100
	fc	750	214	103
5600K	lux	8300	2370	1130
	fc	770	220	105
6500K	lux	8160	2340	1110
	fc	758	217	103
8500K	lux	7700	2210	1050
	fc	714	206	98

All the above tests are based on the condition of 100% brightness.

Technical Data

Model	F200Bi
Power Supply	100V~240V~50/60Hz 2.1A
Max. Power	≈210W
CCT	2700~8500K
Brightness Range	0%-100%
Dimming Curves	linear, s-curve, exponential, logarithmic
FX Modes	11
CRI	≥96
TLCI	≥96
Waterproof Grade of Light Body	IP65
Controlling Methods	DMX 512 Control (support RDM protocol) /2.4GHz Wireless Control/ Bluetooth APP Control
Bluetooth Controlling Distance	Max.30m
2.4G Remote Control Distance	Max.60m
Type-A USB Port	Firmware Upgrade/5V 1A Power Supply
Dimension	Light Body: 650mm*631mm*29mm (excluding DC cable) Controller: 124mm*132mm*270mm
Netweight*	Light Body: 1.83kg (including X bracket and adapter) Controller: 2.77kg

Specifications and data may subject to changes without notice.