

# CineView HE

影眸 HE

User Manual

**ACCsoon**

v1.0

# In the Box

TX+RX



Transmitter x1

发射端 x 1  
送信機 x 1

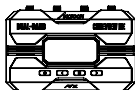

Receiver x1

接收端 x 1  
受信機 x 1

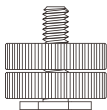

Cold shoe mount adapter x2

双旋钮冷靴座 x 2

コールドシューアダプター x 2

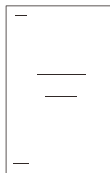

User manual x1

说明书 x 1  
取扱説明書 x 1

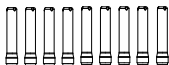

Antenna x 9

天线 x 9  
アンテナ x 9

# In the Box

## TX



Transmitter x1

发射端 x 1

送信機 x 1

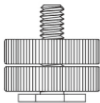

Cold shoe mount adapter x1

双旋钮冷靴座 x1

コールドシューアダプター x1



Antenna x 5

天线 x 5

アンテナ x 5



User manual x1

说明书 x 1

取扱説明書 x 1

# In the Box

## RX



Receiver x1

接收端 x 1

受信機 x 1

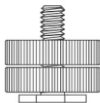

Cold shoe mount adapter x1

双旋钮冷靴座 x1

コールドシューアダプター x1



Antenna x 5

天线 x 5

アンテナ x 5



User manual x1

说明书 x 1

取扱説明書 x 1

# Contents

## ■ Instructions · English

Product Feature .....	1
CineView HE Diagram .....	2
Application .....	4
Instruction .....	5
Specification .....	11
Warranty .....	12
Q&A .....	13

## ■ 使用说明 · 中文版

产品特点 .....	15
认识影眸 HE .....	16
应用场景 .....	18
使用说明 .....	19
产品规格 .....	25
保修说明 .....	26
常见故障及解决方法 .....	27

## ■ 取扱説明 · 日本語

製品特徴 .....	28
CineView HE について .....	29
応用例 .....	31
使用説明 .....	32
製品仕様 .....	38
メーカー保証 .....	39
よく尋ねられる質問 .....	40

# Product Feature

2.4GHz+5GHz Dual-Band Transmission Technology

Latency Less Than 0.06s

Long-Distance Transmission of 1200 ft/350m

HDMI In and Loop out, USB Video Class (UVC) Out

1 Transmitter for 4 Devices, Mix and Match

No Fan Design

Powered by DC Input, NP-F Battery or USB-C

Wireless Remote Monitoring App Accsoon Go

Automatic Channel Selection

Easy Group Pair

FHD Video and High-Quality Audio Transmission

Aerospace-Grade Aluminum Alloy

1.3 inch OLED Screen

Firmware Update with Ease

Quick Installation & Easy to Carry

## Transmitter

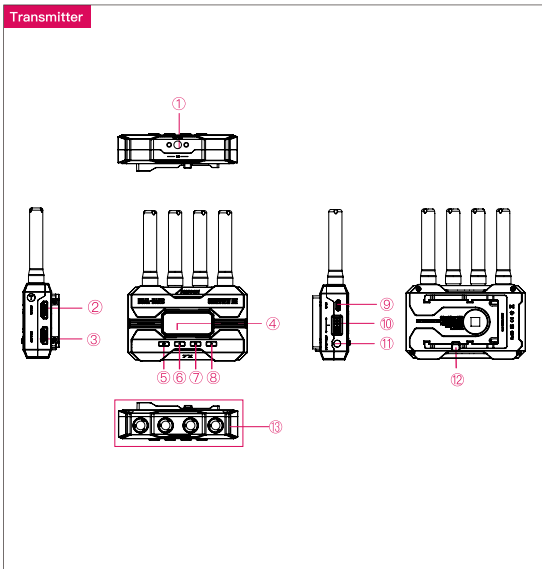

① 1/4 Screw Hole

② HDMI In

③ HDMI Out

④ 1.3 inch OLED Display

⑤ Power On/Off Button

⑥ Left Button

⑦ Menu (OK) Button

⑧ Right Button

⑨ USB-C

⑩ Group Setting Knob

⑪ DC Input

⑫ Battery Lock

⑬ Antenna Connector (RP-SMA Male)

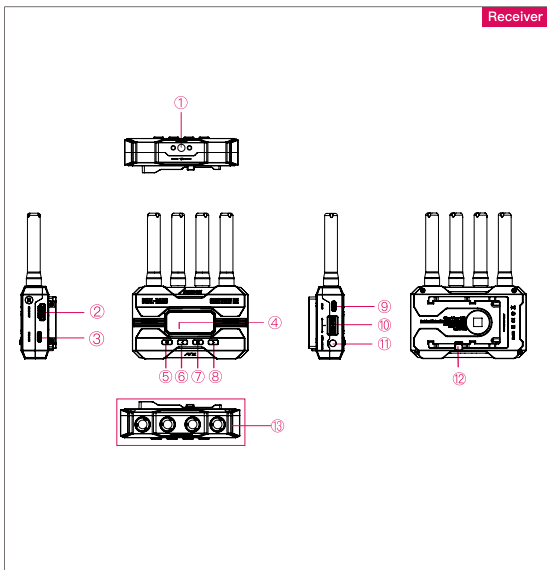

- |                                   |                       |                |
|-----------------------------------|-----------------------|----------------|
| ① 1/4 Screw Hole                  | ② HDMI Out            | ③ UVC Out      |
| ④ 1.3 inch OLED Display           | ⑤ Power On/Off Button | ⑥ Left Button  |
| ⑦ Menu (OK) Button                | ⑧ Right Button        | ⑨ USB-C        |
| ⑩ Group Setting Knob              | ⑪ DC Input            | ⑫ Battery Lock |
| ⑬ Antenna Connector (RP-SMA Male) |                       |                |



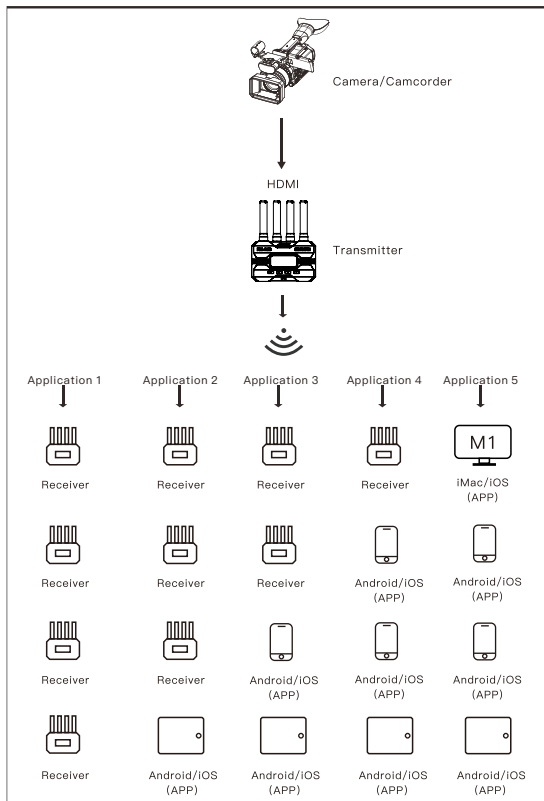

Note: These are five different mix and match combinations for you to choose from.

## 01 How to Install

1. Install the antennas as shown in the picture.
2. Use the cold shoe mount adapter to install the CineView HE onto the camera or camera cage.
3. Use an NP-F970/F750/F550 battery, DC source or USB-C to power the CineView HE.
4. Connect camera HDMI to CineView HE.

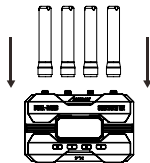

## 02 Power On/Off

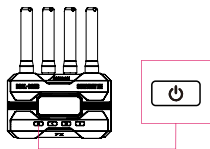

Power On: Press the power on/off button  
Power Off: Hold the power on/off button for 2 seconds.

## 03 Group Setting

1. CineView HE has a group setting knob on each transmitter and receiver. If the transmitter and receiver are set to the same group, they will be paired and connected automatically; otherwise, they will not be paired and connected.
2. If you want to connect multiple receivers (up to 4) to one transmitter at the same time, simply set all receivers and transmitter to the same group.
3. If you want to use more than one group for monitoring under the same application, you need to differentiate the settings of each group.

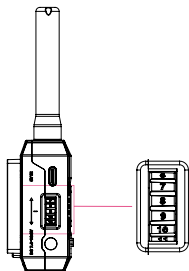

### Note:

1. If you change the grouping settings after the product has been powered on, a reboot is required for the changes to take effect.
2. After changing the group setting, you need to reconnect the transmitter and receiver at close range, otherwise it may fail to pair and connect.

# Instruction

## 04 OLED Display

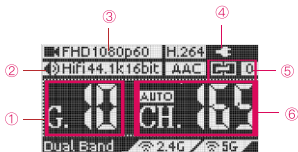

- ① Current group
- ② Input audio information
- ③ Input video information
- ④ Battery level/DC input
- ⑤ Connection status
- ⑥ Current channel

### Connection Status:

Transmitter: the number of connected devices; "0" if none connected.  
Receiver: "1" when connected to the transmitter; otherwise "0".

## 05 Data Rate Setting

- ① High Quality Mode
- ② Normal Mode (Default setting)
- ③ Speed Mode

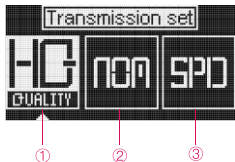

### How to:

Press the menu button to access "Data Rate Setting" → Press the left and right buttons to select → Press the menu button to activate the setting.

## 06 Channel Setting

1. Only the transmitter has the "Channel Setting" menu.
2. The default channel setting is Auto (A). CineView HE will automatically select the channel with the least interference when it is powered on.

(Note: It is recommended that users do not change this setting.)

3. If the user needs to change the channel, please: Press the menu button to enter "Channel Setting" → Press the left and right buttons to select → Press the menu button to confirm → Select "Yes" → Press the menu button to confirm and the setting will take effect after reboot.

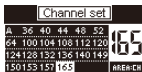

## 07 Network Reset

1. Only the transmitter has the “Network Reset” menu.
2. Users can reset the WiFi SSID and password to factory settings by “Network Reset” menu.



### How to:

Press the menu button to enter “Network Reset” → Select “Yes” → Press the menu button to confirm → Select “Yes” → Press the menu button to reboot, the SSID and password of the 5G WiFi will be reset to factory settings.

## 08 App Monitoring

### 1. App download

Please download the App – Accsoon Go from Google Play Store or iOS Apple App Store.

### 2. Connect the CineView HE with the App

Open the WiFi settings on your mobile devices → Find “Accsoon\_\*\*\*\*” and select it → Enter the default password “12345678” to connect.

**Note:** \*\*\*\* refers to the four characters consisting of numbers and letters that are unique to each product.



Accsoon\_\*\*\*\* 5G  
Tap to share password



### Note:

CineView HE has two WiFi signals, one is 2.4G and another is 5G.

Please confirm that the mobile devices are connected to “Accsoon\_\*\*\*\*”.

# Instruction

## 3. Monitoring

Once successfully connected, open the Accsoon Go App, select “CineView” and tap the “Monitor” button.



**Note:**

If you have any questions about using Accsoon Go App, please refer to Accsoon Go App tutorial videos on Accsoon's official YouTube channel.

## 09 Livestream Setting

There are two ways of using CineView HE for live streaming.

### 1. Livestream via UVC out

- ① Only the CineView HE's receiver has the UVC out.
- ② Use a Type-C cable (user-provided) to connect CineView HE's receiver and mobile phone or computer, then do livestreaming via streaming platforms.

**\*The receiver will act as a live camera.**

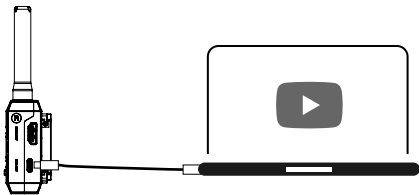

**Note:**

When using the UVC interface for live streaming, support from live streaming platforms is required, such as OBS or YouTube.

## 2. Livestream via Accsoon Go

### ① Change CineView HE transmitter's setting to speed mode

Press the menu button to access "Data Rate Setting" → Use the right button to change to "speed mode" → Press the menu button to activate the setting.

### ② Move to Accsoon Go

Open Accsoon Go and tap the "Live" → Enter streaming RTMP URL and code → Tap "Go Live".



**Note:**

Please refer to the official website where you want to do live streaming for instructions on how to obtain your live streaming URL and code.

## 10 Firmware Update

### 1. Firmware download

Please ensure that your mobile devices can access the Internet via WiFi. Open the Accsoon Go App, select "CineView", then tap the "Firmware Update" button. The App will automatically search for the latest firmware update on the server. Once a new firmware is available, tap "Download" to download the latest firmware to your phone.



# Instruction

**Note:**

Before searching for the latest firmware, please confirm that your mobile device's WiFi can access the Internet so that the App can search for the latest firmware from the server.

## 2. Update

Once the new firmware has been downloaded, connect your mobile devices to the CineView HE → Tap “Next” on Accsoon Go App to update.

**Note:**

1. Make sure the battery level of CineView HE is above 50% before updating.
2. No power cuts should occur during the upgrade process.
3. The CineView HE will reboot automatically when the update is complete.
4. If you have any questions during firmware update, please refer to “Accsoon Go App Tutorial – Firmware update” video on Accsoon's official YouTube channel.

# Specification

	Transmitter	Receiver
Video Input	HDMI	
Video Output	HDMI Loop out	HDMI
HDMI Input Format	1080p 23.98/24/25/ 29.97/30/50/59.94/ 60fps	
HDMI Output Format	1080p 23.98/24/25/ 29.97/30/50/59.94/ 60fps	1080p 24/25/ 30/50/60fps
DC Port	5.5mmx2.1mm center positive	
DC Voltage	7.4-16.8V	
Audio	44.1KHz/48KHz 16bit/24bit PCM	
Latency	<0.06s(Camera latency not included)	
OLED Display	1.3 inch	
Transmission Power	17~20dBm	
Transmission Range	1200ft (No obstacles, no interference)	
Power Consumption	4.5 Watt (Typical)	4.2Watt (Typical)
Operating Environment Temperature	-10~40°C	
Dimensions (Antennas Not Included)	105mmx66mmx32mm	
Weight (Antennas Not Included)	200g	200g



## 01 Warranty Period

1. If there is a quality problem that occurs within 15 days after receiving the product, Accsoon will provide complimentary maintenance or replacement.
2. Under proper use and maintenance, from the date of receipt, Accsoon will provide a one-year warranty on the wireless video transmission system and a three-month warranty on the accessories and cables. Free maintenance service is available during the warranty period.
3. Please keep the proof of purchase and the user manual in a safe place.

## 02 Warranty Exclusions

1. Out of warranty (If the proof of purchase is not available, the warranty will be calculated from the date the product is delivered from the factory).
2. Damage caused by use or maintenance is not following the requirements of the product manual.
3. Unauthorized repair, modification or disassembly.
4. Damage caused by force majeure such as fire, flood, lightning strike, etc.

## 03 Warranty Process

1. Contact your local Accsoon authorized dealers for after-sales service. If there is no local authorized dealers, you can contact our customer service via our email ([support@accsoon.com](mailto:support@accsoon.com)) or website ([www.accsoon.com](http://www.accsoon.com)) and get appropriate support.
2. You will get detailed solutions from the authorized dealers or Accsoon.
3. Accsoon reserves the right to review the damaged product.

**01 Receiver cannot connect to transmitter**

1. Please make sure the transmitter and receiver are set to the same group.
2. Please check that the antennas are securely mounted.

**02 No video displayed**

1. Please check whether the HDMI cable of the camera is correctly plugged into the HDMI IN port of the transmitter.
2. Please check if the video format and other information are shown on the display interface; if not, please check the HDMI cable and see if the HDMI of the camera has a video output.
3. Please check if the HDMI video format of the camera is compatible with the formats supported by the product.

**03 Choppy video**

1. Please check that the antennas are securely mounted.
2. Please make sure there are no metals or cables around the antennas that can cause signal blocking.
3. Please switch to another channel manually.

**04 Mobile devices can't connect to CineView HE**

CineView HE has two WiFi signals, one is 2.4G and another is 5G.  
Please confirm that the mobile devices are connected to "Accsoon\_\*\*\*\*".

**05 App fails to find the latest firmware**

1. Please check if the WiFi connection of your mobile device can access the internet properly.
2. Please check if the mobile device has automatically connected to the CineView HE's WiFi signal. If so, please change to another WiFi connection that can access the internet properly and try again.

## Federal Communications Commission Interference Statement

This equipment has been tested and found to comply with the limits for a Class B digital device, pursuant to Part 15 of the FCC Rules. These limits are designed to provide reasonable protection against harmful interference in a residential installation. This equipment generates, uses and can radiate radio frequency energy and, if not installed and used in accordance with the instructions, may cause harmful interference to radio communications. However, there is no guarantee that interference will not occur in a particular installation. If this equipment does cause harmful interference to radio or television reception, which can be determined by turning the equipment off and on, the user is encouraged to try to correct the interference by one or more of the following measures:

- Reorient or relocate the receiving antenna.
- Increase the separation between the equipment and receiver.
- Connect the equipment into an outlet on a circuit different from that to which the receiver is connected.
- Consult the dealer or an experienced radio/TV technician for help.



[www.accsoon.com](http://www.accsoon.com)