

Aputure[®]



LS 600x Pro

Product Manual

English

Thank You!

Thank you for purchasing the Aputure® "Light Storm" series of Bi-color Point Source light fixture - LS 600x Pro.

The LS 600x Pro features a weather-resistant design, high-power Bi-color Point Source light with adjustable color temperature (2700K ~ 6500K). LS 600x Pro will bring you a more comprehensive and professional lighting solution, including intelligent power supply, movie-level control, and that all aspects of the performance of LS 600x Pro have been fully upgraded.

IMPORTANT SAFETY INSTRUCTIONS

When using this unit, basic safety precautions should always be followed, including the following:

1. Read and understand all instructions before using.
2. Close supervision is necessary when any fixture is used by or near children. Do not leave the fixture unattended while in use.
3. Care must be taken as burns can occur from touching hot surfaces.
4. Do not operate the fixture if a cord is damaged, or if the fixture has been dropped or damaged, until it has been examined by qualified service personnel.
5. Position any power cables such that they will not be tripped over, pulled, or put into contact with hot surfaces.
6. If an extension cord is necessary, a cord with an amperage rating at least equal to that of the fixture should be used. Cords rated for less amperage than the fixture may overheat.
7. Always unplug the lighting fixture from the electrical outlet before cleaning and servicing, or when not in use. Never yank the cord to remove the plug from the outlet.
8. Let the lighting fixture cool completely before storing. Unplug the power cable from lighting fixture before storing and store the cable at assigned space of the carrying case.
9. To reduce the risk of electric shock, do not immerse this fixture in water or any other liquids.

10. To reduce the risk of fire or electric shock, do not disassemble this fixture. Contact cs@aputure.com or take the lighting fixture to qualified service personnel when service or repair is required. Incorrect reassembly may cause electric shock when the lighting fixture is in use.

11. The use of any accessory attachment not recommended by the manufacturer may increase the risk of fire, electric shock, or injury to any persons operating the fixture.

12. Please power this fixture by connecting it to a grounded outlet.

13. Please remove the protective cover before use.

14. Please remove the protection cover before using the reflector.

15. Please do not block the ventilation or donot look at the LED light source directly when it is powered on. Please do not touch the LED light source in any condition.



16. Please do not place the LED lighting fixture near any flammable object.

17. Only use a dry microfiber cloth to clean the product.

18. Please do not use the light fixture in wet condition on account of electric shock may be caused.

19. Please have the product checked by an authorized service personnel agent if the product has a problem. Any malfunctions caused by unauthorized disassembly are not covered by the warranty. The user may pay for maintenance.

20. We recommend only using the original Aputure cable accessories. Please note that any malfunctions casued by using unauthorized accessories are not covered by the warranty. The user may pay for maintenance.

21. This product is certified by RoHS, CE, KC, PSE, and FCC. Please operate the product in full compliance with relevant country's standards. Any malfunctions caused by incorrect use are not covered by warranty. The user may pay for maintenance.

22. The instructions and information in this manual are based on thorough, controlled company testing procedures. Further notice will not be given if the design or specifications change.

SAVE THESE INSTRUCTIONS

FCC Compliance Statement

This device complies with Part 15 of the FCC Rules. Operation is subject to the following two conditions:

- (1) This device may not cause harmful interference.
- (2) This device must accept any interference received, including interference that may cause undesired operation.

Warning: Changes or modifications not expressly approved by the party responsible for compliance could void the user's authority to operate the equipment.

NOTE: This equipment has been tested and found to comply with the limits for a Class B digital device, pursuant to Part 15 of the FCC Rules. These limits are designed to provide reasonable protection against harmful interference in a residential installation. This equipment generates, uses, and can radiate radio frequency energy and, if not installed and used in accordance with the instructions, may cause harmful interference to radio communications. However, there is no guarantee that interference will not occur in a particular installation.

If this equipment does cause harmful interference to radio or television reception, which can be determined by turning the equipment off and on, the user is encouraged to try reorient or relocate the receiving antenna.

- Increase the separation between the equipment and receiver.
- Connect the equipment to an outlet on a different circuit than the receiver is connected to.
- Consult the dealer or an experienced radio/TV technician for help.

RF Warning Statement:

This device has been evaluated to meet general RF exposure requirements.

Components List

Please make sure all accessories listed below are completed before using. If not, please contact with your sellers immediately.

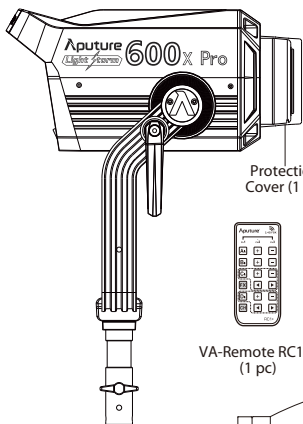

Protection Cover (1 pc)

LS 600x Pro Lamp Head (1pc)



VA-Remote RC1+ (1 pc)

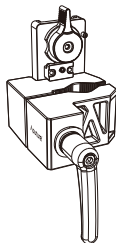

Lightning Clamp (1 pc)

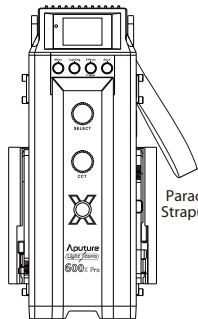

Paracord Strap(1 pc)

LS 600x Pro Control Box (1 pc)

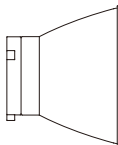

600 Series Hyper Reflector (1 pc)



Neutrik® powerCON AC Power Cable (6m) (1 pc)



LS 600 Series 5-Pin Weatherproof Head Cable (7.5m)(1 pc)

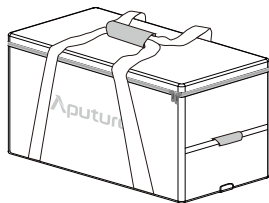

LS 600x Pro Rolling Carrying Case (1 pc)

Tips: The illustrations in the manual are only diagrams for reference. Due to the continuous development of new versions of the product, if there are any differences between the product and the user manual diagrams, please refer to the product itself.

Product Details

1. Lamp Head

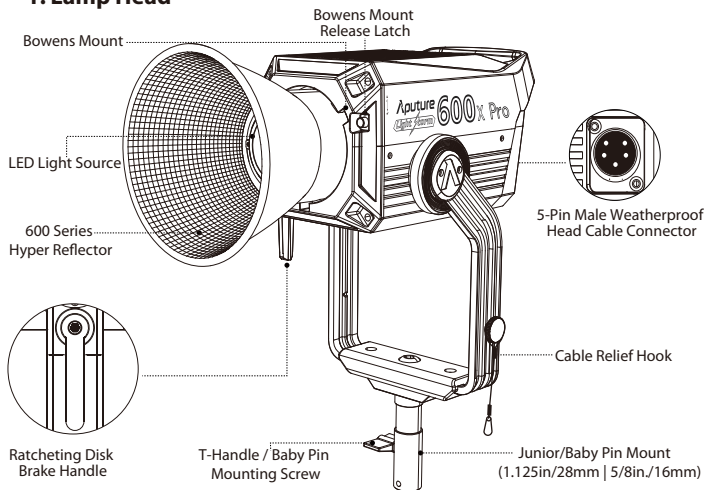

2. Control Box

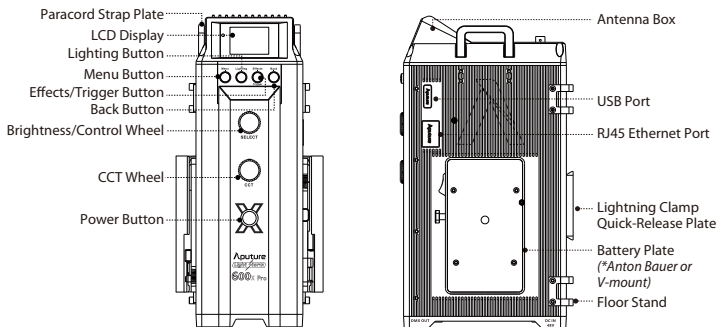

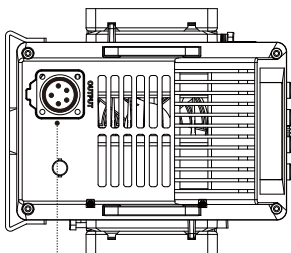

5-Pin Female Head Cable Connector

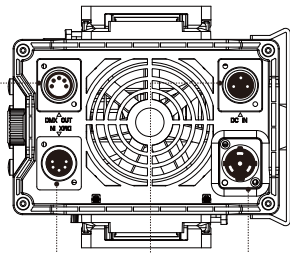

DMX OUT Port

DMX IN Port

48V DC Input (3-Pin XLR)

Neutrik® powerCON Power Input

3. VA-Remote RC1+

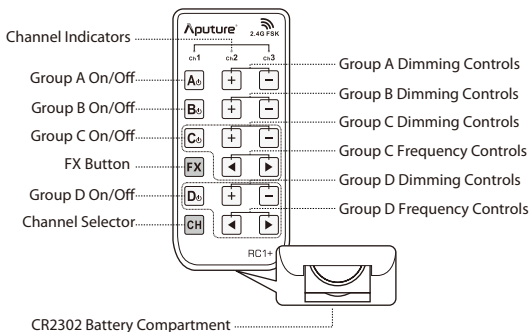

Setting Up the Light

1. Attaching/detaching the Protection Cover

Pull back the retaining pin following the arrow and rotate the cover clockwise to detach the cover. To reattach the cover, insert it into the Bowens mount and rotate counter clockwise.

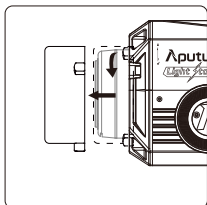
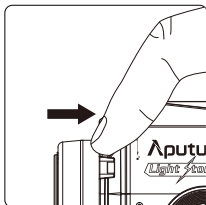

Notice: Always remove the protection cover prior when turning on the light. Always re-install the cover when packing it away.

2. Attaching/detaching the Hyper-Reflector

To install the reflector, pull back the retaining pin, insert the reflector into the BOWENS mount, and rotate it counter clockwise as shown in the following pictures.

To remove the reflector, pull back the retaining pin and rotate the reflector clockwise.

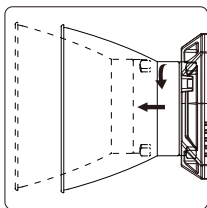
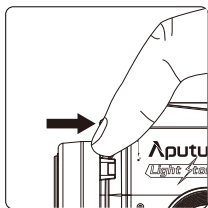

3. Setting Up the Lamp Head

Adjust the lamp head to required angle then tighten the T-Handle to attach the light to stand. Then twist the Ratcheting Disk Brake Handle to fix the Lamp Head. If using a 5/8in/16mm stand (Baby Pin), then mount the Lamp Head onto the stand, and proceed to fix it in place using the T-Handle/Mounting Screw on the Baby Pin Receiver/Mounting Column. If using a 1.125in / 28mm stand (Junior Pin), then mount the Lamp Head into the Junior Pin receiver, and fix it in place using the T-Handle on the stand. Loosen or tighten the Ratcheting Disk Brake Handle on the yoke to adjust the fixture's angle of tilt.

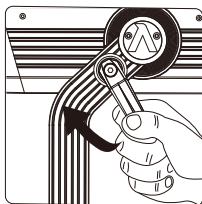
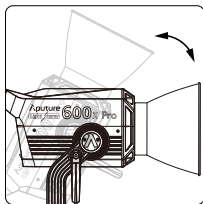
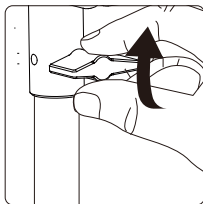

4. Lightning Clamp Operation Instructions

- 1) Clamp the Lightning Clamp onto a light stand.
- 2) To attach the control box, rotate the release lever to unlock the quick-release baseplate, then mount the control box onto the Lightning Clamp (the release lever will automatically spring back).
- 3) To remove the control box, grasp it firmly, then unlock the quick-release plate by turning the release lever, and detach the control box.

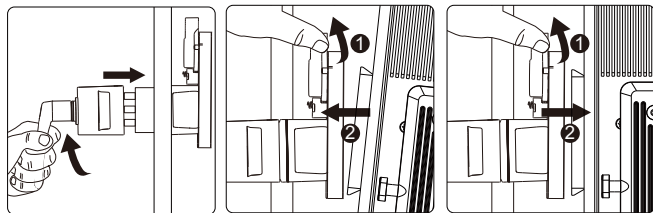

Specifications

Weight	670g / 1.48lbs	Sizes (L*W*H)	10.35x8.74x12.5cm / 4.07x3.44x4.92in
* The Lightning Clamp can clamp onto square or round pipe with a diameter between 2-5cm or 0.79-1.97in.			

5. Connect the Lamp Head to the Control Box

Connect the Lamp Head to the control box using the LS 600 Series 5-Pin Weatherproof Head Cable.

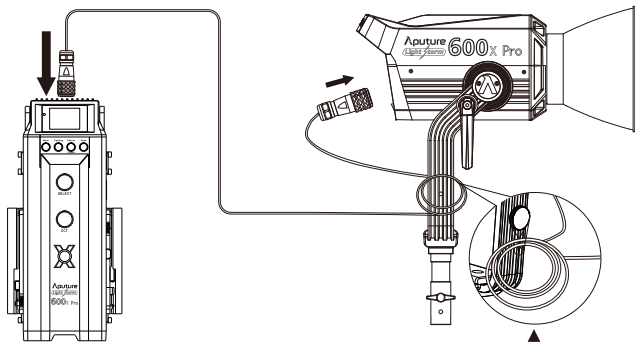

* Hang the cable using the rope to manage and reduce tension on the cable.

* Disconnect the Head Cable by pulling up the collar on the connector. This will disengage its locking mechanism. Do not pull directly.

6. Powering Up the Control Box

1) Powering by AC

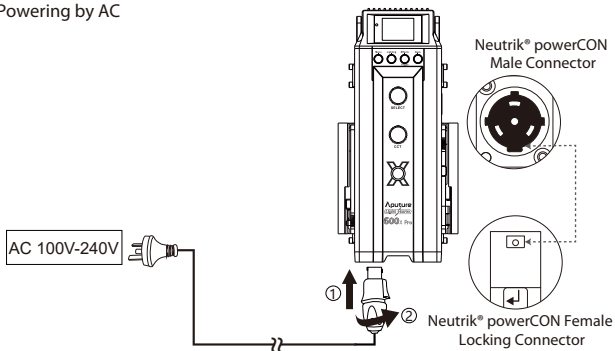

To disconnect the Neutrik® powerCON cable, pull back on the yellow release tab on the cable connector, and rotate the connector counter clockwise. Do not pull directly.

2) Powering by Batteries

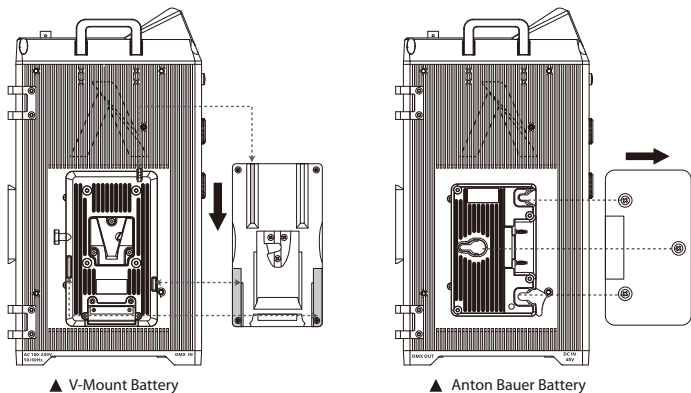

* Battery Requirements: V/AB-Mount Batteries: 14.4V(15A)-28.8V(7.5-15A) DC Input: 48V (15A) (720W Load).
* Customers can choose V-Mount or A-Mount battery plates for their control boxes upon purchase according to their needs.

7. Charge Batteries

When selecting the Exponential (Exp) or Linear dimming curve option, you can charge batteries if the brightness intensity is $\leq 70\%$. When selecting the Logarithmic (Log) dimming curve option, you can charge batteries if the brightness intensity is $\leq 30\%$. When selecting the S-Curve dimming curve option, you can charge batteries if the brightness intensity is $\leq 55\%$.

Operations

1. Press the Power Button to Turn the Light On and Off

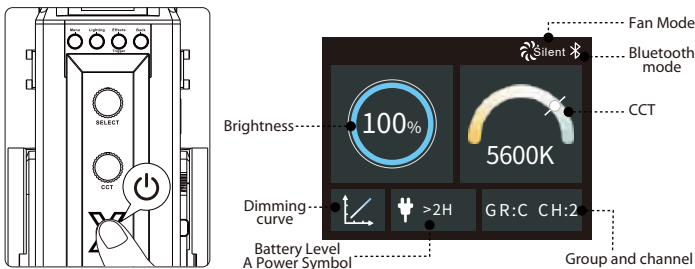

2. Manual Control

1) Rotate the Brightness/Control Knob to adjust the intensity of the light from 0-100% in 0.1% increments. The speed with which you turn the knob will change the rate of increase or decrease.

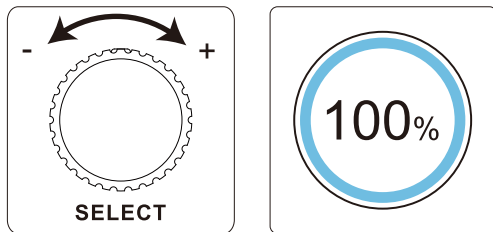

2) Press the MENU button to enter the Menu Interface interface. In the Menu Interface, you will find Battery Power Options, DMX Mode, Dimming Curves, Fan Mode, Studio Mode, Control System, Language, Update, and Effects.

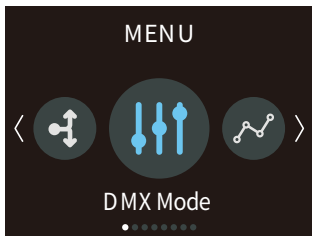

2.1) Output Mode

Press the MENU Button to enter the menu interface, rotate the Select wheel and short press to enter the Output Mode. In the output mode interface, you can choose Constant Output Mode and Max Output Mode. Constant output mode can maintain the brightness output during the process of changing the color temperature. Max Output Mode can make LS 600x Pro perform the current maximum power output.

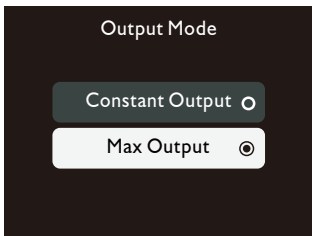

2.2) DMX Mode

Press the MENU Button to enter the menu interface, rotate the Select wheel and short press to enter the DMX mode. Select the DMX address that LS 600x Pro will set to in DMX Address interface. DMX Loss Behavior : Use the Select button to select Black out /fade to Black /Hold last setting/ Hold 2 min& fade Out.

- ① Black out -when the DMX signal is lost, it will be Black out.
- ② Fade to Black -after DMX signal is lost, it will fade to Black in 60 seconds.
- ③ Hold last setting -After DMX signal is lost, remember the last control setting.
- ④ Hold 2 min& Fade Out -After the DMX signal is lost, keep the last control setting for two minutes, and then Fade to Black within 60 seconds.

DMX Profile: Rotate the, and short press to select Lighting 2Channels / Effect 5Channels / Lighting& Effects 6 Channels.

**The fade-out time decreases as the percentage of brightness decreases. When the brightness output is 100%, the fade-out time is 60 seconds, which decreases in sequence.*

***If the signal is reconnected, the DMX console will continue to maintain the signal output as same as before.*

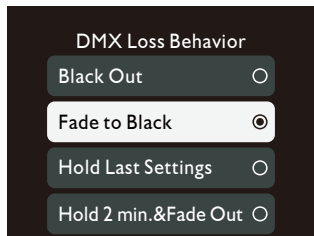
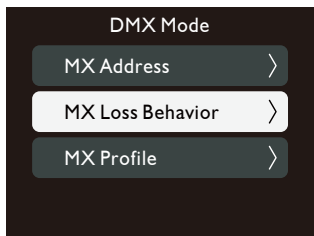

2.3) Dimming Curves

Press the MENU button to enter the menu interface, rotate the Select wheel to select Dimming Curve, and press the MENU button to enter the Dimming Curve selection menu. Using the wheel to choose from exponential (Exp), logarithmic (Log), S-Curve, or linear dimming curves, and press the MENU button to confirm the selection.

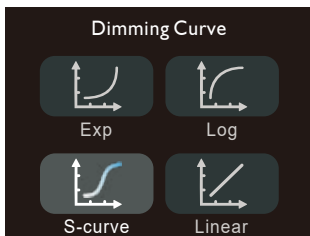

2.4) Fan Mode

Press the MENU button to enter the menu interface, rotate the Select wheel and press to enter the Fan Mode. Turn the Select wheel to choose from smart/ high/ medium/ silent mode, and then press the Select wheel to confirm the selection.

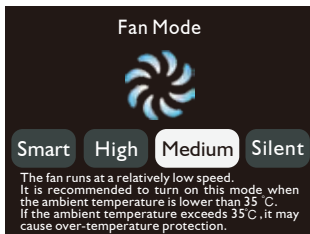

When overheat symbol appears on the light control interface, please follow the text underneath to adjust the Fan Mode to Smart or High. If the internal temperature of the lamp reaches the threshold that needs to be cooled, the lamp will automatically shut down due to overheat protection.

2.5) Studio Mode

Press the MENU button to enter the menu interface, rotate the Select wheel to select and press to enter Studio Mode interface. Then, press the Select wheel again to turn the Studio Mode on or off. When the studio mode is turned on (ON), the lamp can be turned on directly, when the studio mode is turned off (OFF), you need to press the power switch to turn on the lamp.

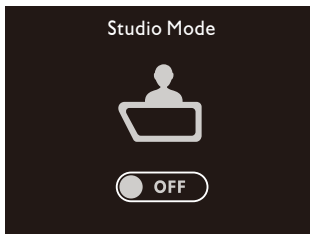

2.6) Frequency Selection

Press the MENU button to enter the menu interface, rotate the Select wheel to select and press to enter Frequency Selection interface. Rotate the Select wheel to adjust the light frequency by 100Hz every turn.



2.7) Control System

LS 600x Pro has four remote control methods: Bluetooth, 2.4G, Lumenradio and Ethernet. Only one control mode can be used at one time.

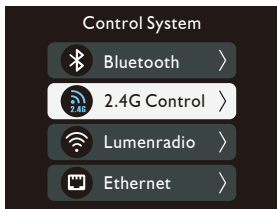

2.7.1) Bluetooth

(1) In the control interface, rotate the Select wheel to select and press to enter the Bluetooth mode interface. Then, you can choose to turn on or off or reset Bluetooth. In the Bluetooth reset interface, you can choose to upgrade or return to the previous menu. Select Bluetooth reset to turn on the Bluetooth for lamp pairing, the Bluetooth serial number will be displayed below.

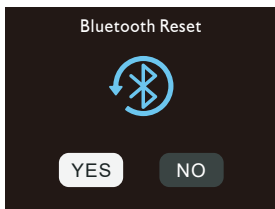
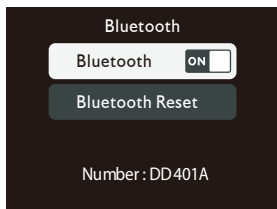

(2) After the Bluetooth reset is successful, you can use a smart terminal (mobile phone or tablet) to pair and connect with the lamp. Then, you are able to control the light via smart terminal. If the Bluetooth reset is unsuccessful, **【Reset Failed】** will pop up and display for 2 seconds followed by returning back to the Bluetooth interface.

2.7.2) 2.4G Control

In the control interface, rotate and press the Select wheel to select 2.4G mode. Turn and press the Select button to switch 2.4G on or off, channel number and group.

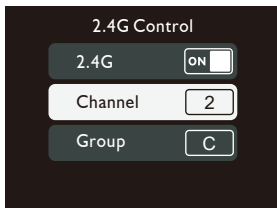

2.7.3) Lumenradio

In the control interface, rotate the Select wheel to select and press to enter the Lumenradio interface. By rotating and pressing the Select wheel, you can switch the Lumenradio on or off, and pairing status.

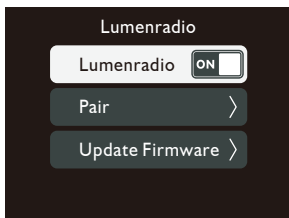

2.7.4) Ethernet

In the control interface, rotate the Select wheel to select and press to enter the Ethernet interface. You can set the IP manually in Manual Set IP interface, or obtain IP automatically in Automatic Obtain IP interface.

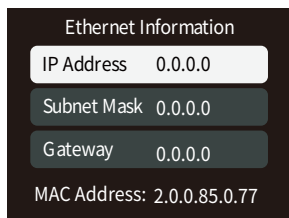

2.8) Language

Press the MENU button to enter the menu interface, rotate the Select wheel to select and press to enter the Language menu. You can rotate the Select wheel to select English or Chinese, and then press the Select wheel to confirm the selection.



2.9) Factory reset

Press the MENU button to enter the menu interface, rotate the Select wheel to select and press to enter the Factory Reset interface. The factory settings are: fan is in smart mode, channel is 1, group is A, light effect brightness value is 50%, light effect mode color temperature value is 5600K, normal mode brightness is 50%, normal light mode color temperature is 5600K, output mode-maximum output mode, Bluetooth mode is turned on, studio mode is turned off, dimming curve-linear, DMX channel number 001, English, fireworks light effect, frequency 5.



2.10) Update

Press the MENU button to enter the menu interface, rotate the Select wheel to select and press to enter the Update menu. You can update the firmware in the Update interface, and view the firmware version number. Firmware updating can also be done via Sidus Link app using OTA (Over the Air Technology).

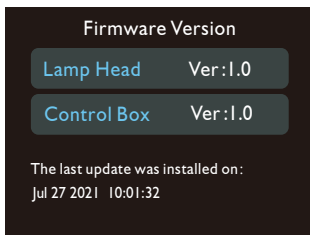
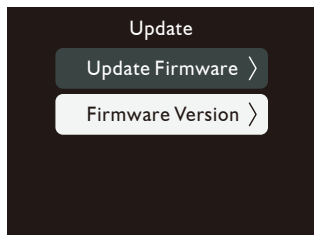

2.11) Custom FX

Press the MENU button to enter the menu interface, rotate the Select wheel to select and press to enter the Custom FX. You can choose to enter Picker FX, Music FX, or Touchbar FX interface. Each type can save 10 custom FXs. In the name of each FX, "NO FX" means unsaved FX, and "Untitled" means saved FX.

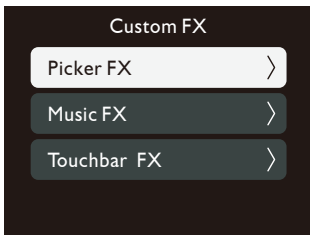

2.12) Battery Power Options

1. Battery Wake Up: for A-Mount or V-Mount lithium battery, you need to activate the lithium battery from over-discharge protection. Select the lithium battery specification 14.4V/26V and enter the Wake Up Batteries interface, confirm Activate to output 3A current in order to activate the lithium battery; After activation, check whether the lithium battery has a voltage output. If so, the activation is successful, otherwise the activation fails.

2. Full power output: a single lithium battery meets 360W continuous output (14.4V lithium battery maximum output current 30A, 26V lithium battery maximum output current 15A), two lithium batteries can meet the input power requirement of 720W, and the lamp can achieve 100% illumination Output.

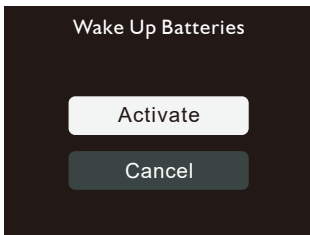
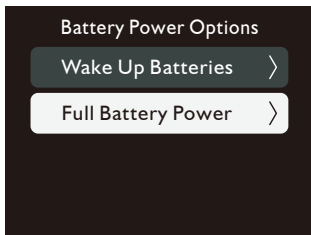

3. Effects

Press the Effects button to enter the Effects Mode. rotate the Select wheel to select and press to enter the Effects interface. You can choose from Paparazzi, Firework, Faulty Bulb, Lightning, TV , Pulsing, Strobe, Explosion, and Fire effect.



a. Paparazzi Effect

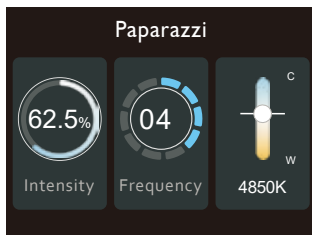

b. Fireworks Effect

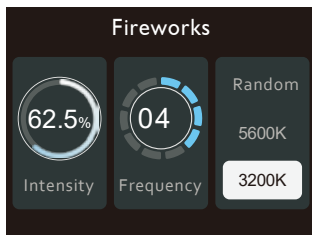

c. Faulty Bulb Effect

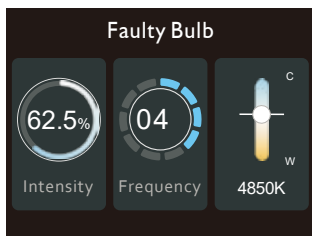

d. Lightning Effect

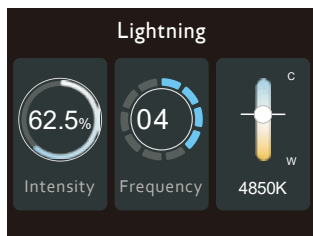

** In Lighting FX mode, manually short press the Trigger button to trigger the lightning single mode, Manually long press the Trigger button to enter the lightning cycle mode, and long press the Trigger button again to exit the lightning cycle mode.*

e. TV Effect

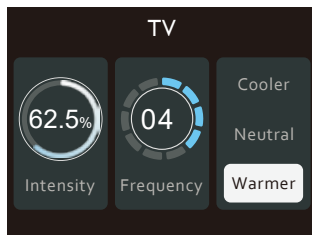

f. Pulsing Effect

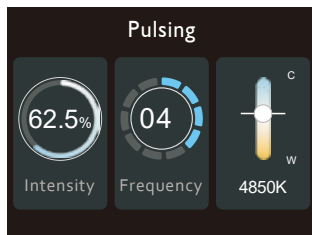

g. Strobe Effect

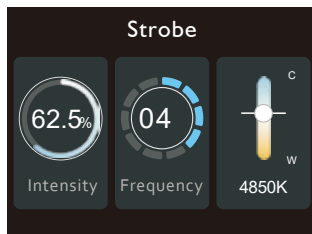

h. Explosion Effect*

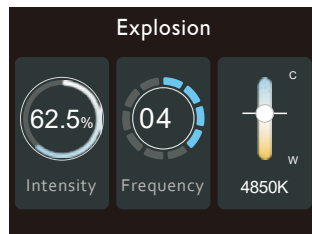

i. Fire

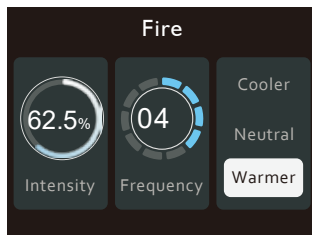

** In the Explosion FX mode, the light effect needs to be triggered by the Trigger button, and the light effect is triggered once by pressing the Trigger button once.*

- 1) Short press the select wheel to select frequency adjustment. Twist the wheel to change the brightness of the lamp between 0%~100%.
- 2) Short press the select wheel to select frequency adjustment. Twist the wheel to change the frequency of the lamp between 1~10; R means random.
- 3) Rotate the CCT knob to change the color temperature value of the lamp, [CCT] value (2700K-6500K).

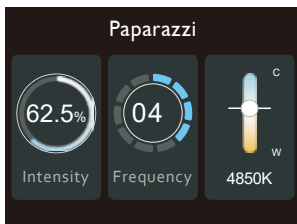

** In the light Effect mode, if the power is suddenly cut off and the light is re-energized, the display screen displays the interface before the power is cut off and responds according to the display of the interface.*

- 4) In any condition, you can return to the regular lighting interface directly by pressing the Lighting button.
- 5) In any condition, you can return to the light effect interface by pressing the Effects button.

3. Remote Control

You can control the LS 600x Pro from any channel or group configuration.

** Light Storm lights have three channels (1/2/3) and four groups (A/B/C/D).*

** Only groups "C" or "D" can be used to control brightness and lighting effects, while groups "A" and "B" can only be used to control brightness.*

- 1) Configuring channel settings on the remote



▲ Press the CH button to toggle between channels 1, 2, and 3)



▲ "ch2" indicator lights

2) Adjusting brightness

Press A/B/C/D to turn the lights on or off , press (\oplus / \ominus) to adjust the brightness of the light from 0 to 100% accordingly.

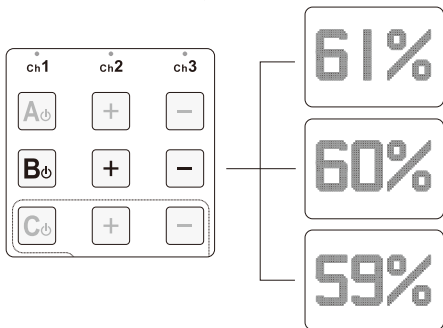

** This remote will not work when the light is in DMX mode.*

***The remote control will only control the operation of the light when the fixture is in 2.4Ghz Wireless Control Mode.*

3) FX Control

Press the ($\text{FX} + \text{C} \ominus / \text{D} \ominus$) button to enter or exit lighting effect mode. Press the ($\text{FX} + \oplus / \ominus$) to toggle between different effects.

Press the (\oplus / \ominus) buttons to adjust the output of the light. Press the ($\blacktriangleleft / \blacktriangleright$) buttons to toggle the effect frequency.

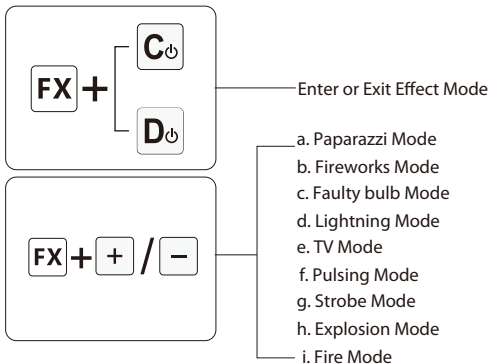

** The remote control can only be used to operate lighting effects if the lights are in groups C or D.*

4. Connecting to DMX

1) Connect a standard DMX controller

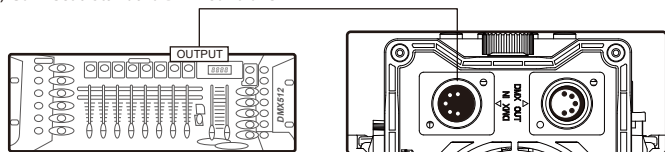

DMX512

Connecting DMX to only one 600x Pro

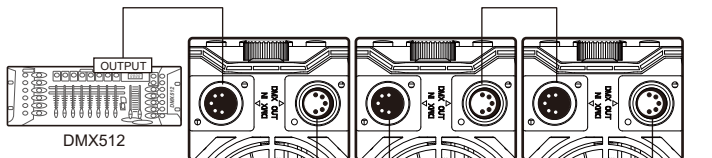

DMX512

Daisy chaining multiple lights using DMX

* The DMX interface schematic is shown in the pictures below:

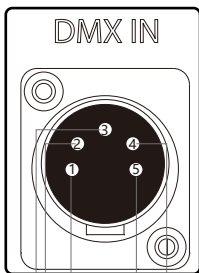

Data 1+
(Primary Data Link)

Data 1-
(Primary Data Link)

Signal Common

Data 2- (Optional
Secondary Data Link)

Data 2+ (Optional
Secondary Data Link)

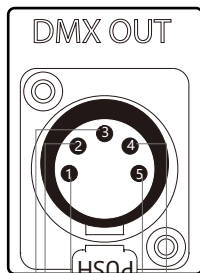

Data 1+
(Primary Data Link)

Data 1-
(Primary Data Link)

Signal Common

Data 2- (Optional
Secondary Data Link)

Data 2+ (Optional
Secondary Data Link)

2) Channel Selection

In DMX mode, match the channel of your DMX controller with the light, and then adjust accordingly.

* The default DMX channel is "001".

** The range of DMX channels is 1 to 512.

5. Controlling Device Via DMX

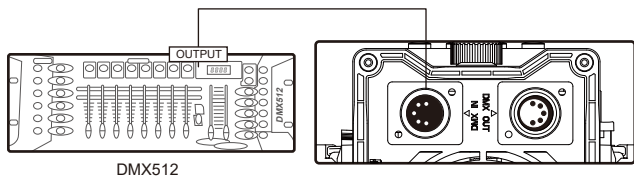

2) DMX Chart

Mode	Channel	Function								
DMX Profile 1: Lighting	1	INT: 0-100%								
	2	CCT: 2700K-6500K								
DMX Profile 2: Effects	1	INT: 0-100%								
	2	CCT: 2700K-6500K								
	3	Paparazzi	Fireworks	Fault Bulb	Lighting	TV	Pulsing	Strobe	Explosion	Fire
	4	FRQ: 1-10/R								
	5	/	/	/	Initial value/ Trigger/Loop	/	/	/	Initial value/ Trigger/Loop	/
DMX Profile 3: Lighting&Effects	1	INT: 0-100%								
	2	CCT: 2700K-6500K								
	3	Lighting <-> EFFECTS: 0-100%								
	4	Paparazzi	Fireworks	Fault Bulb	Lighting	TV	Pulsing	Strobe	Explosion	Fire
		FRQ: 1-10/R								
	5	/	/	/	Initial value/ Trigger/Loop	/	/	/	Initial value/ Trigger/Loop	/

* In DMX mode, intensity, FX frequency and lighting effects can only be controlled by a DMX controller.

** When controlling multiple LS 600x Pro lights independently (i.e., A and B), offset each light by 5 channels. If you set light A at DMX 001, set light B at DMX 006, to control A and B separately on the DMX controller.

6. Using the Sidus Link APP

You can download the Sidus Link app from the iOS App Store or Google Play Store for enhancing the functionality of the light. Please visit sidus.link/app/help for more details regarding how to use the app to control your Aputure lights.



Get Sidus Link[®] App



[Sidus.link/app/help](https://sidus.link/app/help)

Specifications

Operating Current	8A	Power Supply	100V-240V 50Hz/60Hz
Power Input	≤720W	Power Output	≤600W
CRI	≥96	TLCI	≥96
CQS	≥95	CCT	2700K-6500K
Radio Frequency	2.4GHz	Channels	1/2/3
Groups	A/B/C/D	Operating temperature	-20°C~45°C
Battery charging (voltage)	14.4V(12V-16.8V), 26/28.8V(25V-29.4V)	Battery charging (current)	3A
Battery requirement	14.4V-15A ≥180Wh 26V-8.5A ≥180Wh 28.8V-7.5A ≥180Wh	Cooling Method	Active Cooling
Control Methods	On-board,2.4GHz,DMX512, Sidus Link (Sidus Mesh TM), Art-net, Ethernet,LumenRadio	Wireless Operating Range (2.4GHz)	≤100m
Wireless Operating Range (Bluetooth)	≤80m	Wireless Operating Range (LumenRadio)	≤100m
Screen Type	LCD (Adaptive Brightness)	Waterproofing	Dust&Light Rain

Sizes (L*W*H)	Lamp Head w/o Yoke	30.2X14.7X14.9cm/11.88*5.78*5.86in
	Lamp Head w Yoke	30.2X43.6X24.8cm/11.88*17.16*5.86in
	Controller box (V-Mount)	32.3*17.9*14.2cm/12.71*7.04*5.59in
	Controller box (Gold-Mount)	32.3*17.9*13.2cm/12.71*7.04*5.19in
	Lighting Clamp	10.35*8.74*12.5cm/4.07*3.44*4.92in
Weight	Lamp Head	5.16kg/11.37lbs
	Controller box (V-Mount)	4.89kg/10.78lbs
	Controller box (Gold-Mount)	4.89kg/10.78lbs
	Lighting Clamp	670g/1.48lbs
	Total weight	19.07 kg/42.04lbs

**The malfunctions caused by water in the lamp body are not covered under the warranty.*

**If the LS 600x Pro is used in a heavy rain, it is recommended to use the tilt angle range of the lamp head as shown below:*

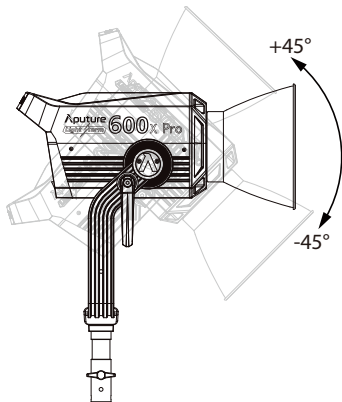

Photometrics

Distance	CCT	1m	3m	5m
Bare Bulb	3200K	11630	1364	524
	5600K	16060	1880	728
600 Series Hyper Reflector	3200K	45300	4010	1426
	5600K	63900	5610	1996

** This is an averaged result. The luminance of your individual unit may vary slightly from this data.*

Trademarks

Bowens is a trademark registered by Bowens in China and other countries.

Anton Bauer is a trademark registered by Anton Bauer in the US and other countries.

Neutrik® is a trademark registered by Neutrik® in the US and other countries.