

Aputure®

**Light**  **storm**

LS 600d Pro  
**Product Manual**

English

# Thank You!

## **Thank you for purchasing the Aputure Light Storm 600d Pro.**

The Aputure LS 600d Pro is an incredibly powerful and feature-packed fixture, containing all pre-existing Light Storm features such as Bowens Mount modularity, and wireless remote & app control, as well as adding IP54 weatherproof build quality, wireless DMX, a DC battery input, and battery charging functionality.

## IMPORTANT SAFETY INSTRUCTIONS

When using this unit, basic safety precautions should always be followed, including the following:

1. Read and understand all instructions before using.
2. Close supervision is necessary when any fixture is used by or near children. Do not leave the fixture unattended while in use.
3. Care must be taken as burns can occur from touching hot surfaces.
4. Do not operate the fixture if a cord is damaged, or if the fixture has been dropped or damaged, until it has been examined by qualified service personnel.
5. Position any power cables such that they will not be tripped over, pulled, or put into contact with hot surfaces.
6. If an extension cord is necessary, a cord with an amperage rating at least equal to that of the fixture should be used. Cords rated for less amperage than the fixture may overheat.
7. Always unplug the lighting fixture from the electrical outlet before cleaning and servicing, or when not in use. Never yank the cord to remove the plug from the outlet.

8. Let the lighting fixture cool completely before storing.
9. To reduce the risk of electric shock, do not immerse this fixture in water or any other liquids.
10. To reduce the risk of fire or electric shock, do not disassemble this fixture. Contact [cs@aputure.com](mailto:cs@aputure.com) or take it to qualified service personnel when service or repair work is required. Incorrect reassembly may cause electric shock when the lighting fixture is in use.
11. The use of an accessory attachment not recommended by the manufacturer may increase the risk of fire, electric shock, or injury to any persons operating the fixture.
12. Power this fixture by connecting it to a grounded outlet.
13. Please remove the protective cover before powering on the light.
14. Please remove the protection cover before using the reflector.
15. Please do not block the ventilation and do not look at the light directly when it is powered on.
16. Please do not place the LED lighting fixture near any flammable object.
17. Only use a dry microfiber cloth to clean the product.
18. Please have the product checked by an authorized service personnel agent if your product has a problem.
19. The malfunctions caused by unauthorized disassembly are not covered under the warranty.
20. We recommend only using the original Aputure cable accessories. Please note that our warranty for this product does not apply to any repairs required due to any malfunctions of unauthorized Aputure accessories, although you may request such repairs for a fee.



21. This product is certified by RoHS, CE, KC, PSE, and FCC. Please operate the product in full compliance with the operation standards. Please note that this warranty does not apply to repairs arising from malfunctions, although you may request such repairs on a chargeable basis.
22. The instructions and information in this manual are based on thorough, controlled company testing procedures. Further notice will not be given if the design or specifications change.

# SAVE THESE INSTRUCTIONS

## FCC Compliance Statement

This device complies with Part 15 of the FCC Rules. Operation is subject to the following two conditions:

- (1) This device may not cause harmful interference.
- (2) This device must accept any interference received, including interference that may cause undesired operation.

**Warning:** Changes or modifications not expressly approved by the party responsible for compliance could void the user's authority to operate the equipment.

**NOTE:** This equipment has been tested and found to comply with the limits for a Class B digital device, pursuant to Part 15 of the FCC Rules. These limits are designed to provide reasonable protection against harmful interference in a residential installation. This equipment generates, uses, and can radiate radio frequency energy and, if not installed and used in accordance with the instructions, may cause harmful interference to radio communications. However, there is no guarantee that interference will not occur in a particular installation. If this equipment does cause harmful interference to radio or television reception, which can be determined by turning the equipment off and on, the user is encouraged to try reorient or relocate the receiving antenna.

- Increase the separation between the equipment and receiver.
- Connect the equipment to an outlet on a different circuit than the receiver is connected to.
- Consult the dealer or an experienced radio/TV technician for help.

## RF Warning Statement:

This device has been evaluated to meet general RF exposure requirements.

## Components List

Please make sure all accessories listed below are completed before using. If not, please contact with your sellers immediately.

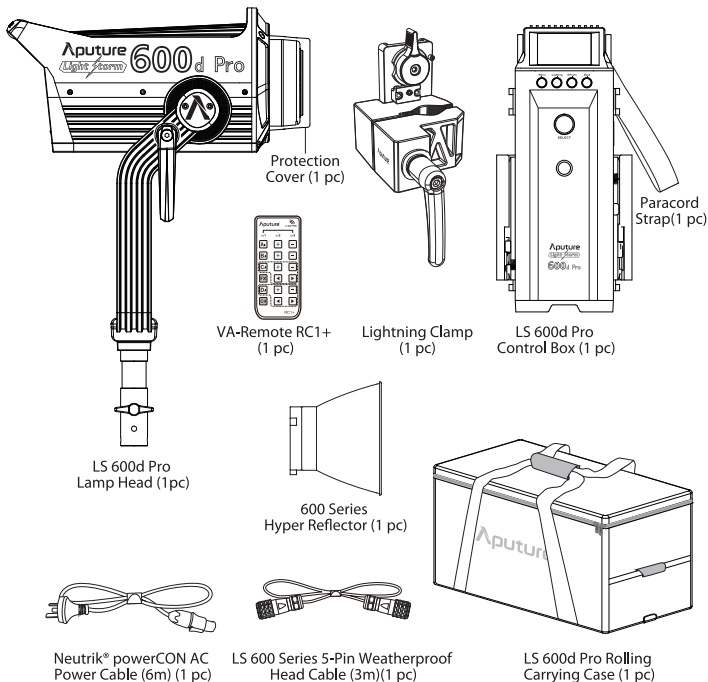

# Product Details

## 1. Lamp Head

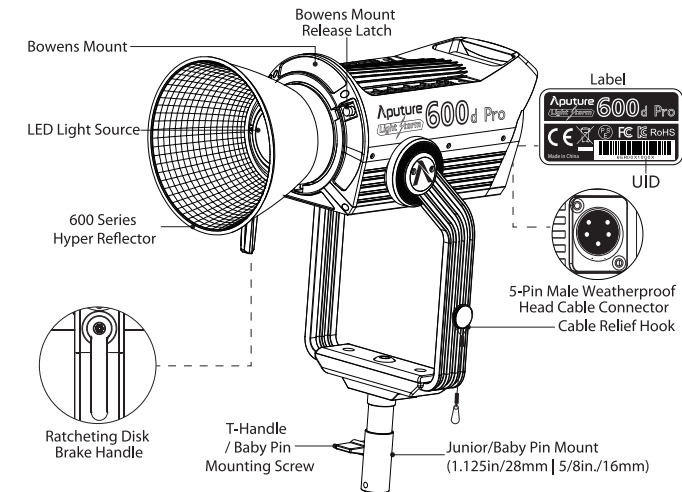

## 2. Control Box

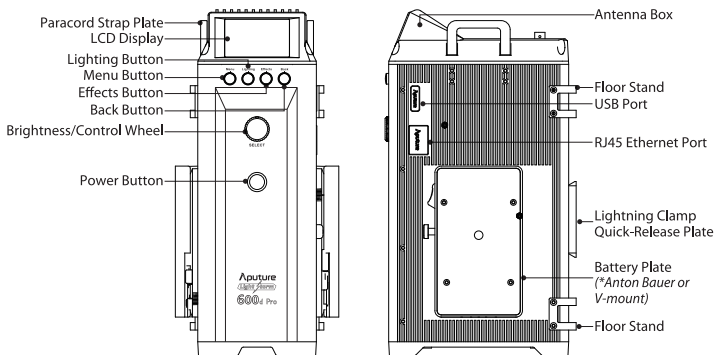

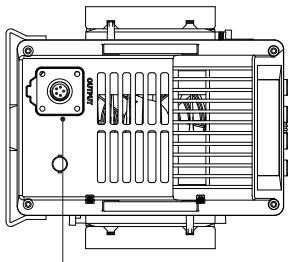

5-Pin Female Head Cable Connector

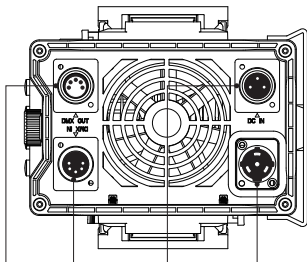

DMX OUT Port

DMX IN Port

48V DC Input (3-Pin XLR)

Neutrik® powerCON Power Input

### 3. VA-Remote RC1+

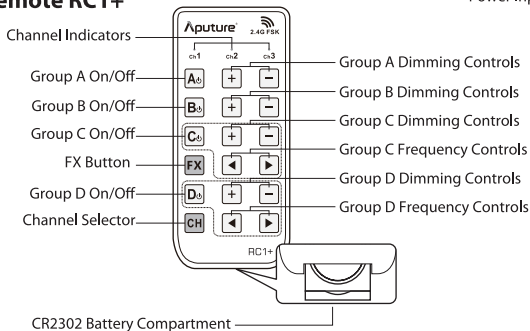

## Setting Up the Light

### 1. Attaching/detaching the protection cover

Pull back the retaining pin, rotate the cover clockwise, then detach the cover.

To reattach the cover, insert it into the Bowens mount and rotate counterclockwise.

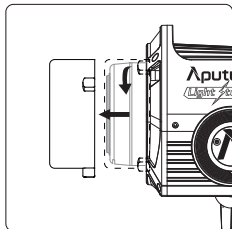
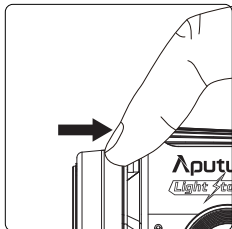

*Notice: Always remove the protection cover prior to turning on the light. Always re-install the cover when packing it away.*

## 2. Attaching/detaching the Hyper-Reflector

To install the reflector, pull back the retaining pin, insert the reflector into the Bowers mount, and rotate it counterclockwise as shown in the following pictures.

To remove the reflector, pull back the retaining pin and rotate the reflector clockwise.

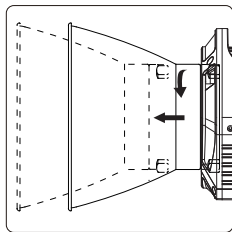
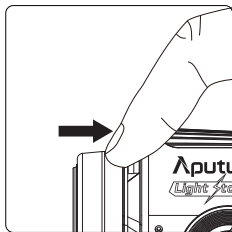

## 3. Setting up the Lamp Head

If using a 5/8in / 16mm stand (Baby Pin), then mount the Lamp Head onto the stand, and proceed to fix it in place using the T-Handle/Mounting Screw on the Baby Pin Receiver/Mounting Column.

If using a 1.125in / 28mm stand (Junior Pin), then mount the Lamp Head into the Junior Pin receiver, and fix it in place using the T-Handle on the stand.

Loosen or tighten the handbrake locking mechanism on the yoke to adjust the fixture's angle of tilt.

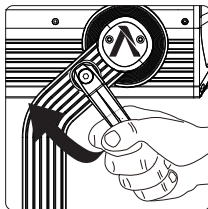
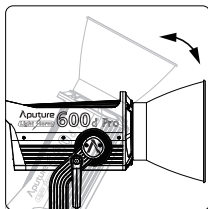
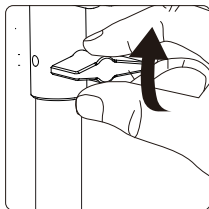



## 4. Lightning Clamp Operation Instructions

- 1) Clamp the Lightning Clamp onto a light stand.
- 2) To attach the control box, rotate the release lever to unlock the quick-release baseplate, then mount the control box onto the Lightning Clamp (the release lever will automatically spring back).
- 3) To remove the control box, grasp it firmly, then unlock the quick-release plate by turning the release lever, and detach the control box.

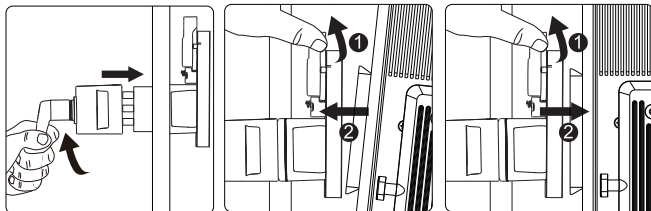

### Specifications

Weight	670g / 1.48lbs	Sizes (L*W*H)	10.35x8.74x12.5cm / 4.07x3.44x4.92in
* The Lightning Clamp can clamp onto square or round pipe with a diameter between 2-5cm or 0.79-1.97in.			

## 5. Connect the Lamp Head to the control box

Connect the Lamp Head to the control box using the LS 600 Series 5-Pin Weatherproof Head Cable.

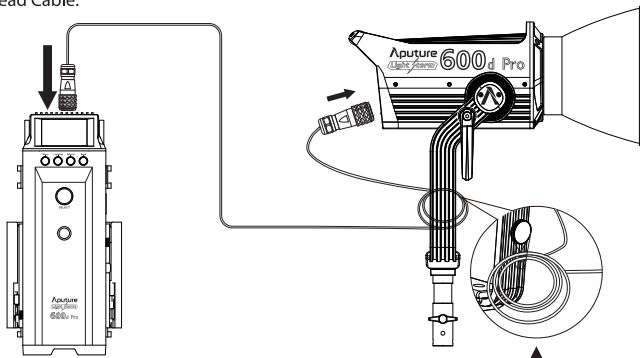

\* Hang the cable using the rope to manage and reduce tension on the cable.

\* Disconnect the Head Cable by pulling up on the collar on the connector. This will disengage its locking mechanism.

## 6. Powering up the controller

### 1) Powering by AC

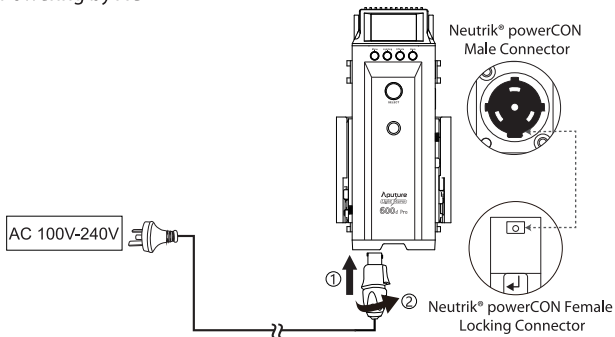

To disconnect the Neutrik® powerCON cable, pull back on the yellow release tab on the cable connector, and rotate the connector counterclockwise.

### 2) Powering by Batteries

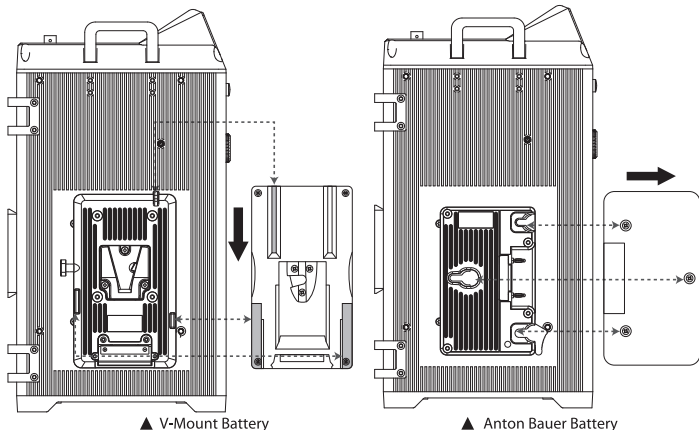

\* Battery Requirements: V/AB-Mount Batteries: 14.4V(15A)-28.8V(7.5-15A) DC Input: 48V (15A) (720W Load).

\* Customers can choose V-Mount or A-Mount battery plates for their control boxes upon purchase according to their needs.

## 7. Charge batteries

When selecting the Exponential (Exp) or Linear dimming curve option, you can charge batteries if the brightness intensity is  $\leq 70\%$ . When selecting the Logarithmic (Log) dimming curve option, you can charge batteries if the brightness intensity is  $\leq 30\%$ . When selecting the S-Curve dimming curve option, you can charge batteries if the brightness intensity is  $\leq 55\%$ .

## Operations

### 1. Press the power button to turn the light on and off

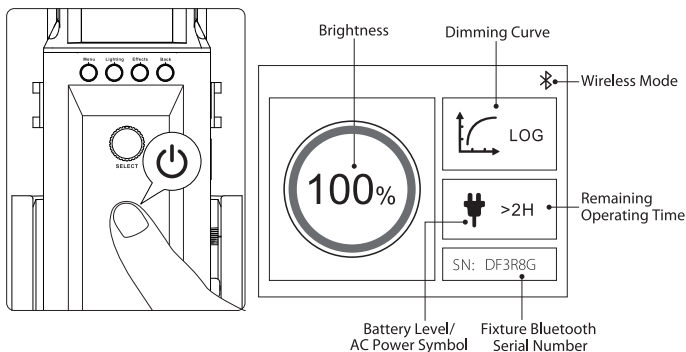

### 2. Manual Control

1) Rotate the Brightness/Control Knob to adjust the intensity of the light from 0-100% in 0.1% increments. The speed with which you turn the knob will change the rate of increase or decrease.

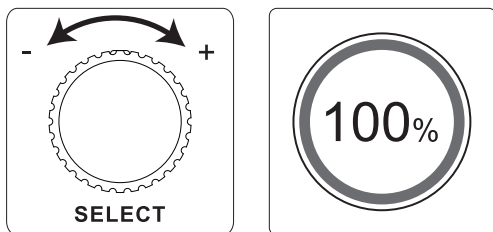

2) Press the MENU button to enter the System Menu interface. In the System Menu you'll find Battery Power Options, DMX Mode, Dimming Curves, Fan Mode, Studio Mode, Control System, Language, Update, and Effects.

### 2.1) DMX Mode

Press the Menu button to enter the System Menu. Rotate the Control Knob to select DMX Mode, and short press the knob to enter DMX Mode.

In DMX Mode you can enter the DMX Address menu to select the DMX address the LS 600D Pro will be set to.

When DMX Loss Behavior is ON, the light will memorize the state before disconnecting DMX. When DMX Loss Behavior is OFF, the light will restore to the state before entering the DMX mode if disconnecting DMX.

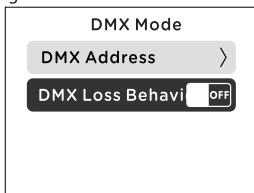

### 2.2) Dimming Curves

Press the Menu button to enter the System Menu. Rotate the Control Knob to select Dimming Curves, and short press the knob to enter the Dimming Curves selection menu. Rotate the Control Knob to choose between the four dimming curve options: Exponential (Exp), Logarithmic (Log), S-Curve, and Linear.

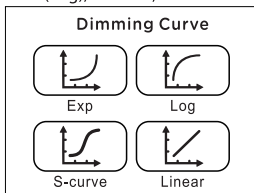

### 2.3) Fan Mode

Press the Menu button to enter the System Menu. Rotate the Control Knob to select Fan Mode, and short press the knob to enter Fan Mode. You can then short press the Control Knob to toggle the Fan Mode ON or OFF. When the Fan Mode is ON, then the fans in the fixture will spin continuously. If the Fan Mode is OFF, the fixture will automatically shut down for protection when the internal temperature of the fixture reaches the Cooling Threshold.

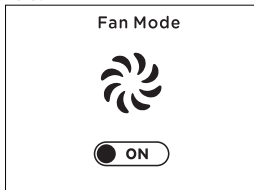

## 2.4) Studio Mode

Press the Menu button to enter the System Menu. Rotate the Control Knob to select Studio Mode, and short press the knob to enter Studio Mode. You can then short press the Control Knob to toggle the Studio Mode ON or OFF. When Studio Mode is ON, the light will turn on as soon as it receives power. When Studio Mode is OFF, the power button must be pressed to turn on the light.

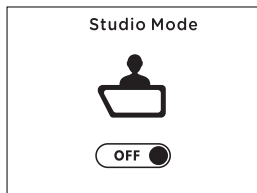

## 2.5) Control System

The LS 600d Pro has four remote control methods available aside from on-board control: Bluetooth, 2.4G, Lumenradio, and Art-Net. Only one remote control mode can be used at a time.

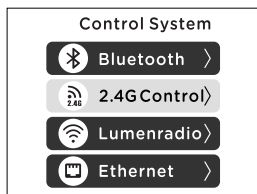

### 2.5.1) Bluetooth

(1) In the Control System Menu, use the Control Knob to select Bluetooth to activate Sidus Mesh control. Use the Control Knob to select your desired action. Short press the Control Knob while selecting Bluetooth to toggle the Bluetooth connection ON/OFF. Enter the Bluetooth Reset Menu to start the Bluetooth Pairing process for the light. Select YES to begin the Pairing Process or NO to return to the previous menu.

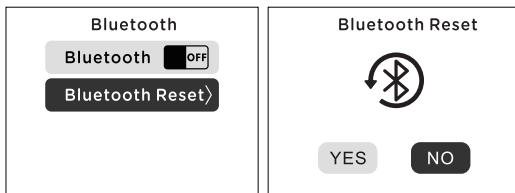

(2) After resetting the light's Bluetooth connection, your mobile phone or tablet will be able to connect to and control the light using the Sidus Link App. If the Bluetooth Reset Fails, a [Reset Failed] screen will appear, and the light will return to Bluetooth mode after 2 seconds.

#### 2.5.2) 2.4G Control

In the Control System Menu, use the Control Knob to select 2.4G Control to activate 2.4G RF FSK Remote Control. Use the Control Knob to select your desired action. Short press the Control Knob while selecting 2.4G to toggle the 2.4 RF connection ON/OFF. Use the Control Knob to select the desired Channel and Group for the fixture. These RF settings correspond to the available buttons on the included remote.

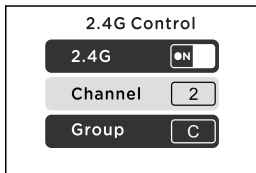

#### 2.5.3) Lumenradio

In the Control System Menu, use the Control Knob to select Lumenradio to activate Wireless DMX Control. Use the Control Knob to select your desired action. Short press the Control Knob while selecting Lumenradio to toggle the Lumenradio connection ON/OFF. Use the Control Knob to activate the Pairing or Firmware Update functions.

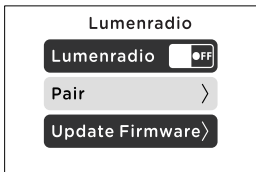

#### 2.5.4) Art-Net

In the Control System Menu, use the Control Knob to select Ethernet to activate Art-Net control. In the Ethernet Mode you can manually set the desired IP address or obtain an Automatic IP address. This mode allows you to view the Local IP, Remote IP, Gateway, and MAC Address information.

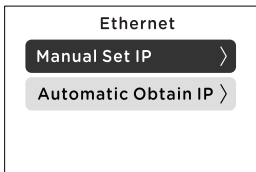

## 2.6) Language

Press the Menu button to enter the System Menu. Rotate the Control Knob to select Language, and short press the knob to enter Language Selection Mode. Use the Control Knob to select from the available languages. Initial languages include English and Simplified Chinese.



## 2.7) Update

Press the Menu button to enter the System Menu. Rotate the Control Knob to select Update, and short press the knob to enter Update Mode. In Update Mode you can select Update Firmware or Firmware Version using the Control Knob.

By selecting Update Firmware, you can update the fixtures existing firmware, by inserting a compatible USB drive, formatted to Fat16/32, with the new firmware files. By selecting Firmware Version, you can view your current firmware version, and when that firmware was created.

You can also update the device's firmware using the OTA firmware update function built into Sidus Link.



## 2.8) Effects

Press the Menu button to enter the System Menu. Rotate the Control Knob to select Effects, and short press the knob to enter Effects Mode.

You can also enter this mode by pressing the Effects button on the control box. In Effects mode use the Control Knob to select the desired lighting effect.

a. Paparazzi Effect

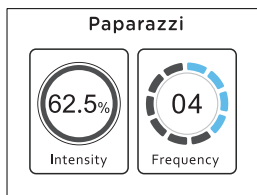

b. Fireworks Effect

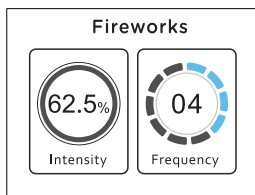

c. Faulty Bulb Effect

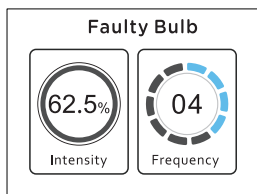

d. Lightning Effect\*

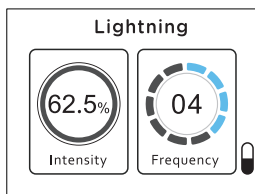

\* In the Lightning Effect, short press the Effects button to trigger the effect. Long press the Effects button for 2 seconds to activate cycle mode for the lightning effect.

e. TV Effect

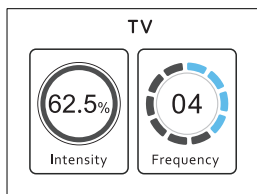

f. Pulsing Effect

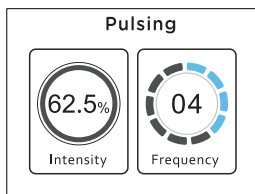

g. Strobe Effect

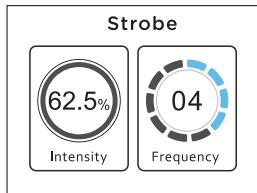

h. Explosion Effect\*

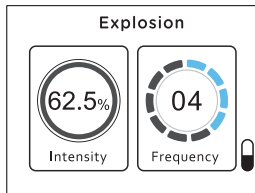

\* In the Explosion Effect, short press the Effects button to trigger the effect.



When in Lighting FX mode, short press the Control Knob to toggle between Intensity and Frequency Adjustment.

In Intensity Adjustment Mode, rotate the Control Knob to adjust the intensity from 0% to 100% in 0.1% increments.

In Frequency Adjustment Mode, rotate the Control Knob to adjust the frequency of the effect from 1 to 10 and R (Random) as displayed on the screen.

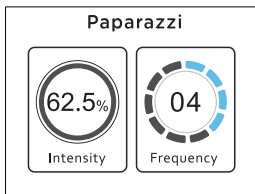

*\* If the light is powered off, upon turning on again, the light resumes its last saved setting.*

3) The Lighting Button can be used to return to the main lighting interface in from any menu.

4) The Effects button can be used to enter the Effects interface from any menu.

### 3. Remote Control

You can control the LS 600d Pro from any channel or group configuration.

*\* Light Storm lights have three channels (1/2/3) and four groups (A/B/C/D).*

*\* Only groups "C" or "D" can be used to control brightness and lighting effects, while groups "A" and "B" can only be used to control brightness.*

1) Configuring channel settings on the remote



▲  
Press the CH button to toggle between channels 1, 2, and 3)



▲  
"ch2" indicator lights

## 2) Adjusting brightness

Press A/B/C/D to toggle the lights on or off, press (  $\oplus$  /  $\ominus$  ) to adjust the brightness of the light from 0 to 100% accordingly.

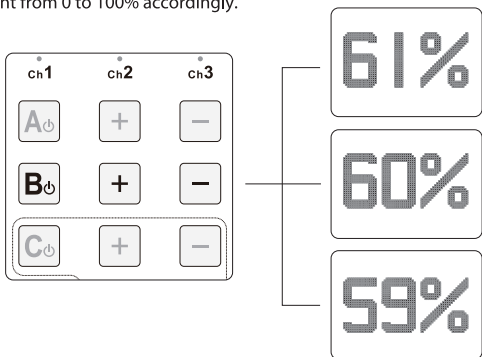

\* This remote will not work when the light is in DMX mode.

\*\* The remote control will only control the operation of the light when the fixture is in 2.4Ghz Wireless Control Mode.

## 3) FX Control

Press the (FX+  $\oplus$  /  $\ominus$ ) button to enter or exit lighting effect mode. Press the (FX+  $\oplus$  /  $\ominus$ ) to toggle between different effects.

Press the (  $\oplus$  /  $\ominus$  ) buttons to adjust the output of the light. Press the (  $\blacktriangleleft$  /  $\blacktriangleright$  ) buttons to toggle the effect frequency.

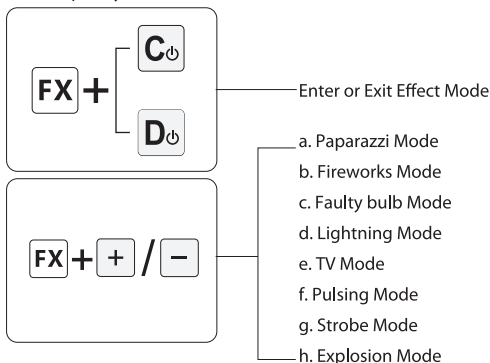

\* The remote control can only be used to operate lighting effects if the lights are in groups C or D.

## 4. Connecting to DMX

1) Connect a standard DMX controller

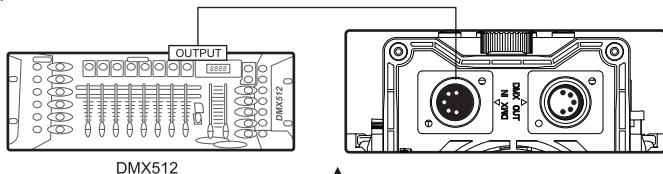

DMX512

Connecting DMX to only one 600d Pro

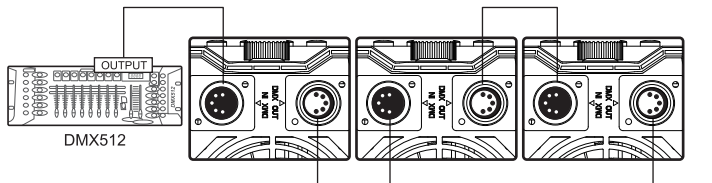

DMX512

Daisy chaining multiple lights using DMX

\* The DMX interface schematic is shown in the pictures below:

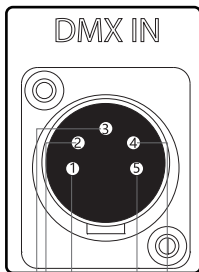

Data 1+  
(Primary Data Link)

Data 1-  
(Primary Data Link)

Signal Common

Data 2- (Optional  
Secondary Data Link)

Data 2+ (Optional  
Secondary Data Link)

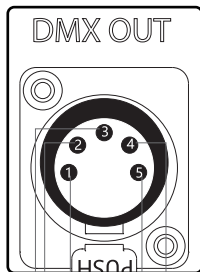

Data 1+  
(Primary Data Link)

Data 1-  
(Primary Data Link)

Signal Common

Data 2- (Optional  
Secondary Data Link)

Data 2+ (Optional  
Secondary Data Link)

2) Channel Selection

In DMX mode, match the channel of your DMX controller with the light, and then adjust accordingly.

\* The default DMX channel is "001".

\*\* The range of DMX channels is 1 to 512.

## 5. Controlling Device Via DMX

- 1) Connect the DMX controller's OUTPUT to the 600d Pro's controller INPUT as shown in the figure below.

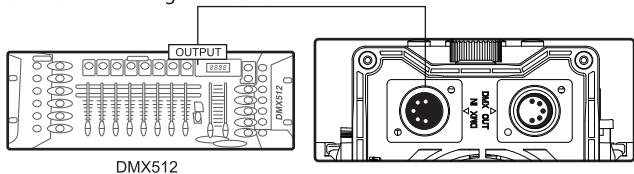

### 2) DMX Chart

DMX Channel Values / Functions (5 DMX Channels)		
Channel	Value	Function
1		Dimmer
	0-255	Intensity 0 to 100%
2		Mode Selection
	0-127	Manual Mode
	128-255	FX Mode
3		FX Control
	0-19	Paparazzi
	20-39	Fireworks
	40-59	Faulty Bulb
	60-79	Lightning
	80-99	TV
	100-119	Pulsing
	120-139	Strobe
	140-159	Explosion
	160-255	Undefined
		FX Frequency Control
	0-19	1

4	20-39	2
	40-59	3
	60-79	4
	80-99	5
	100-119	6
	120-139	7
	140-159	8
	160-179	9
	180-199	10
	200-219	R
	220-255	Undefined
5		IN Lightning mode
	0-9	Start Point
	10-127	Single Trigger
	128-255	Cycle Mode
		IN Explosion Mode
	0-9	Start Point
	10-127	Single Trigger
	128-255	Undefined

\* In DMX mode, intensity, FX frequency and lighting effects can only be controlled by a DMX controller.  
 \*\* When controlling multiple 600d Pro lights independently (i.e., A and B), offset each light by 5 channels.  
 If you set light A at DMX 001, set light B at DMX 006, to control A and B separately on the DMX controller.

## 6. Using the Sidus Link APP

You can download the Sidus Link app from the iOS App Store or Google Play Store for enhancing the functionality of the light. Please visit [sidus.link/app/help](https://sidus.link/app/help) for more details regarding how to use the app to control your Aputure lights.



Get Sidus Link® App



[Sidus.link/app/help](https://sidus.link/app/help)

## Specifications

Operating Current	8A	Power Supply	100V~240V 50Hz/60Hz
Power Input	≤720W	Power Output	≤600W
CRI	≥96	TLCI	≥96
CQS	≥94	CCT	5600K±200K
Radio Frequency	2.4GHz	Channels	1/2/3
Groups	A/B/C/D	Operating Temperature	-20°C~45°C
Battery Charging (Voltage)	12-16.8V/21-29.4V	Battery Charging (Amperage)	3A
Battery requirement	14.4V-15A ≥180Wh 26V-8.5A ≥180Wh 28.8V-7.5A ≥180Wh	Cooling Method	Active Cooling
Control Methods	On-board, 2.4GHz, Sidus Link (Sidus Mesh™), Art-net, LumenRadio	Wireless Operating Range (2.4GHz)	≤100m
Wireless Operating Range (Bluetooth)	≤80m	Wireless Operating Range (LumenRadio)	≤100m
Screen Type	LCD (Adaptive Brightness)	Weatherproofing	Dust & Light Rain

Dimensions (L*W*H)	Lamp Head w/o Yoke	30.8*15.61*15.01 cm / 12.13*6.15*5.91in
	Lamp Head w/ Yoke	30.8*25.03*45.6cm / 12.13*9.85*17.95 in
	Control Box (V-Mount)	32.41*17.9*14.28cm / 12.76*7.05*5.62in
	Control Box (Gold Mount)	32.41*17.9*13.27cm / 12.76*7.05*5.22in
	Lightning Clamp	10.35*8.74*12.5cm / 4.07*3.44*4.92in
Weight	Lamp Head	4.64kg / 10.23lbs
	Control Box (V-Mount)	5.8kg / 12.79lbs
	Control Box (Gold Mount)	5.8kg / 12.79lbs
	Lightning Clamp	670g / 1.48lbs
	Total w/ Case	18.2kg / 40.12lbs

\* The malfunctions caused by water in the lamp body are not covered under the warranty.

\* If the LS 600d Pro is used in a heavy rain, it is recommended to use the tilt angle range of the lamp head as shown below:

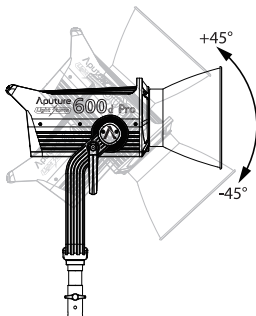

## Photometrics

Distance	1m	3m	5m
Bare Bulb	22150 (lux)	2600 (lux)	1020 (lux)
	2058 (fc)	242 (fc)	95 (fc)
600 Series Hyper Reflector	98500 (lux)	8500 (lux)	3000 (lux)
	9150 (fc)	790 (fc)	280 (fc)

*\* This is an averaged result. The luminance of your individual unit may vary slightly from this data.*

## Trademarks

Bowens is a trademark registered by Bowens in China and other countries.

Anton Bauer is a trademark registered by Anton Bauer in the US and other countries.

Neutrik® is a trademark registered by Neutrik® in the US and other countries.