

Product Manual

English

Foreward

Thank you for purchasing the Aputure AL-MW.

Instructions

- Please read this product manual carefully.
 - Keep this product manual. Always include this product manual when passing the products on to third parties.
 - Heed all warnings and follow all instructions in this product manual.
- WARNING:** Do not place the product in a place where there are corrosive chemicals to protect the product from corrosion, corrosion may cause the product to malfunction.
- Use only a microfiber and dry cloth for cleaning the product.
 - Operate carefully to not cause any damage by dropping or physical shocking it.
 - Do not leave the product in excessive heat, high temperatures can cause the product to malfunction.
 - Please have the product checked by the authorized service or agent if your product has some problems. Please note that this warranty does not apply to repair arising out of the malfunction of unauthorized disassembly, although you may request such repairs on a chargeable basis.
 - Use of original Aputure cable accessories is recommended. Please note that this warranty does not apply to repairs arising out of the malfunction of non-original Aputure accessories, although you may request such repairs on a chargeable basis.
 - The product is certified by RoHS and CE. Please operate the product in full compliance with the operation standards. Please note that this warranty does not apply to repair arising from malfunction, although you may request such repairs on a chargeable basis.
 - The instructions and information in this manual are based on thorough, controlled company testing procedures. Further notice will not be given if the design and specifications change.

Intended Use

- Intended use of the Aputure AL-MW includes:
- The user has read the instructions of this manual.
 - The user is using the products within the operating conditions and limitations described in this product manual.
 - "Improper use" means using the products other than as described in these instructions or under operating conditions which differ from those described herein.

Item Check List

Package includes the following items:

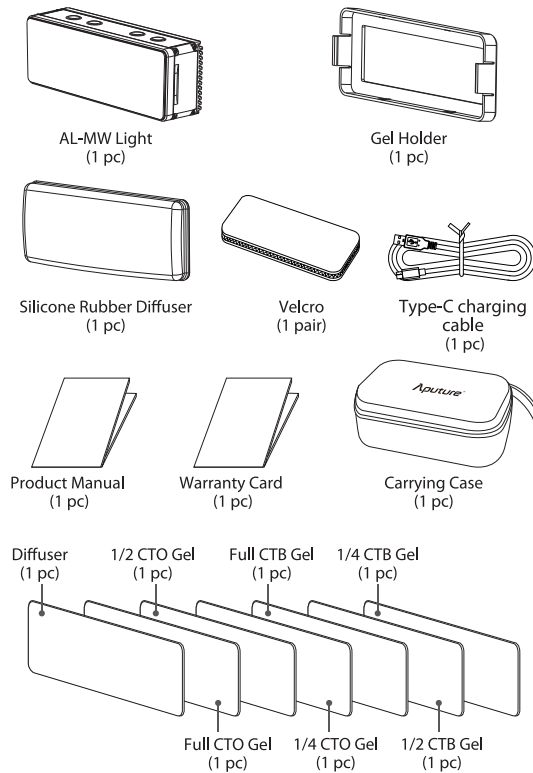

Nomenclature

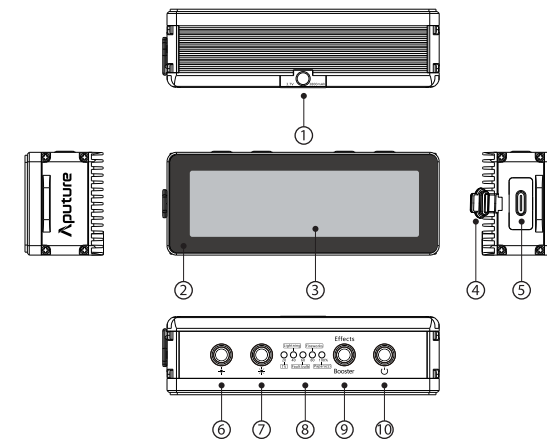

- ① 1/4" Fixed Screw Hole
- ② Lens
- ③ COB Light
- ④ Rubber Plug
- ⑤ USB Type-C Charging Port
- ⑥ Brightness "-" Button
- ⑦ Brightness "+" Button
- ⑧ Battery/Brightness/Effect Indicator
- ⑨ Booster/Effect Button
- ⑩ Power Switch

Installations and Operations

1. Charging

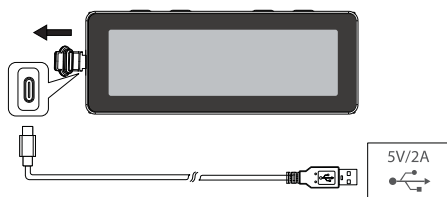

*While charging, the current green battery indicator is always on, and the low battery indicator is cycled in sequence, 5 continuous green lights means a full charge.

*When the power is low, the red light will blink, and the MW will automatically shut down after 30 seconds.

*The MW can charge while in use when brightness is below 40%.

*The light will turn off in conditions higher than 45 °C. The red indicator will blink in these conditions.

*Please use 5V/2A charger or power bank for charging, otherwise (use 5V/1A) the brightness will be reduced or cause power protection.

2. Power ON/OFF

Long press power switch

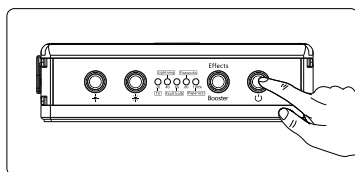

3. Brightness Adjustment

Short press + or - to change the brightness.

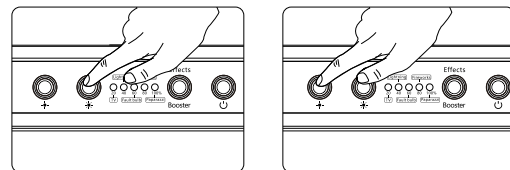

*10 adjustable brightness levels:

The first blue indicator blinks ---10%

The first blue indicator is always on ---20%

A blue indicator is always on, a blue indicator is blinking ---30%

Two blue indicators are always on ---40%

⋮

Four blue indicators are always on, a blue indicator is blinking ---90%

All five blue indicators are always on ---100%

*The brightness will turn down to 40% level and below when using 5V/0.5A, 5V/1A charger.

*Long press + or - to quickly adjust brightness.

4. Effect Mode Adjustment

Long press the effect button to enter the effect mode, the blue light indicates the current effect mode, and then short press the effect button to make effect selection: Paparazzi mode, Fireworks mode, Fault bulb mode, Lightning mode, TV mode.

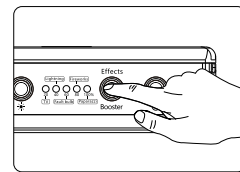

5. Booster Mode

- 1) Short press Booster button to trigger booster mode.
- 2) Short press Booster button again to shut down the booster mode.
- 3) Booster mode lasts for 60 seconds and can be used again after 40 seconds.
- 4) The MW will not have booster mode if plugged into a charger.
- 5) In the booster mode, the brightness will be increased by 50% on the basis of the original maximum, achieving one key brightness booster.

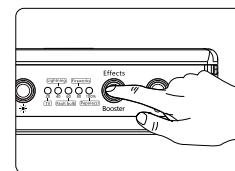

*Use charge via USB Type-C for power supply, not be able to trigger booster mode.

*When the battery temperature is high, not be able to trigger booster mode.

6. The Use of Diffuser and Gel

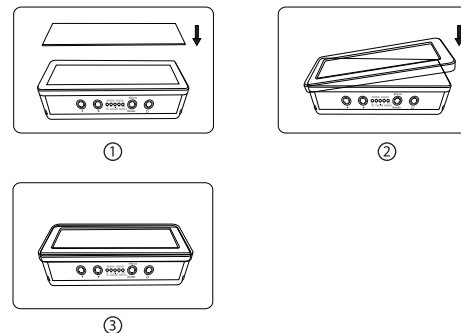

7. The Use of Silicone Rubber Diffuser

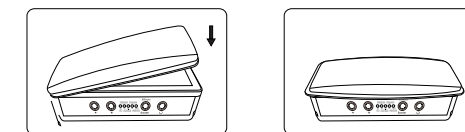

8. The Use of Velcro

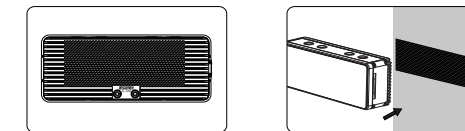

Specifications

Color Temperature	5600±200K			
CRI	>95			
TLCI	>95			
Illuminance	Distance	0.3M	0.5M	1M
	Maximum Brightness	4000LUX	1300LUX	300LUX
Battery Type	Lithium-polymer Battery (3.7V 3800mAh)			
Rated Power	10W			
Working Temperature	0 °C to +45 °C			
Waterproof Level	IP68(10M)			
Battery Working Time	>1.33h(maximum brightness)			
	>24h(minimum brightness)			
Dimension	117.5*43.5*32mm			

*The data is average brightness, it will shift slightly within different lights.